

Technical Drawing & Accessories

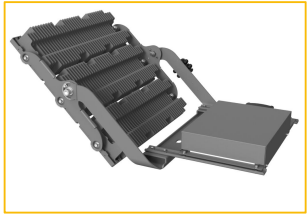

Bracket Mounting

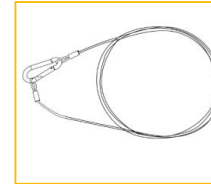
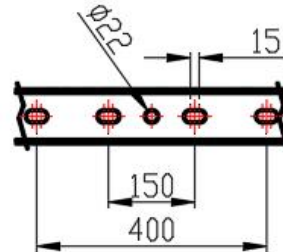
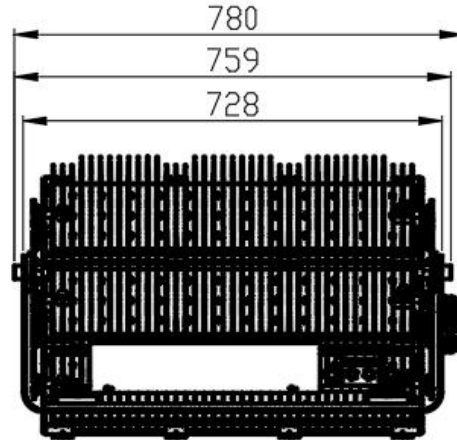
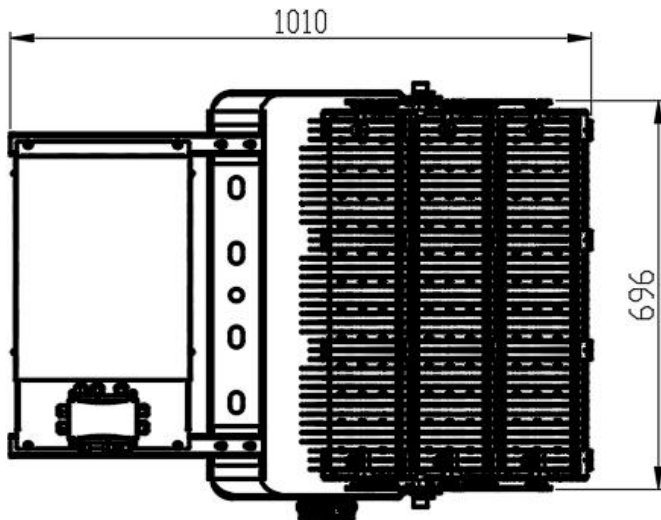
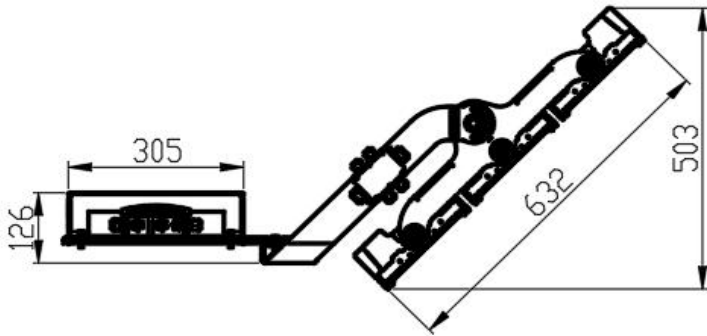

Safety Rope
Auxiliary safety device to prevent accidents.



Precision Aiming Device
Accurate adjustment of luminaire projected position.

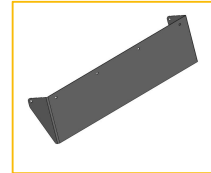

Visor

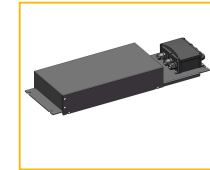

Internal Application
Driver 2 (IP65)
Used with lamp body installation.

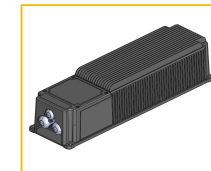

Internal Application
Driver 1 (IP65)
Used with lamp body installation.

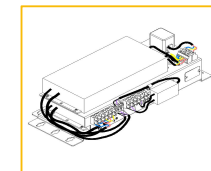

Internal Application
Driver 3 (IP20)
Used when separated from lamp body for installation.