

1 HANNAH@HANDRAIL 98 TYPICAL PLAN
SCALE 1:8

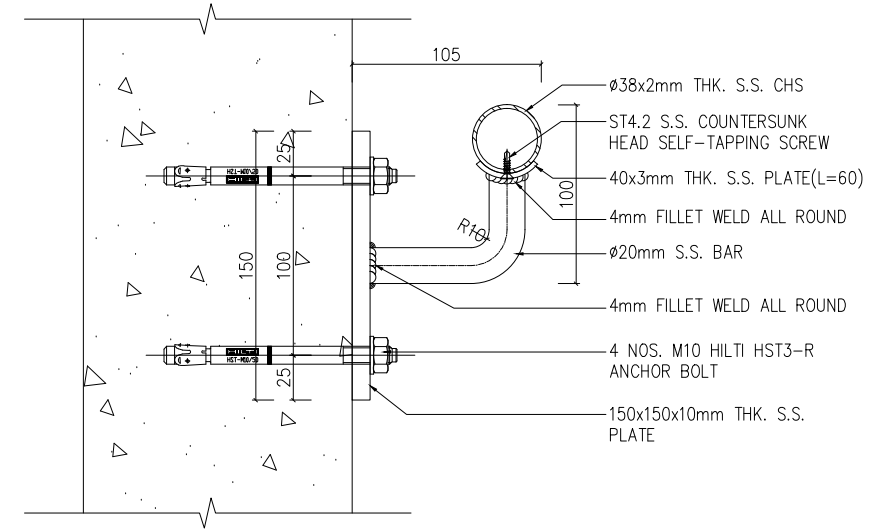

1 DETAIL
SCALE 1:2

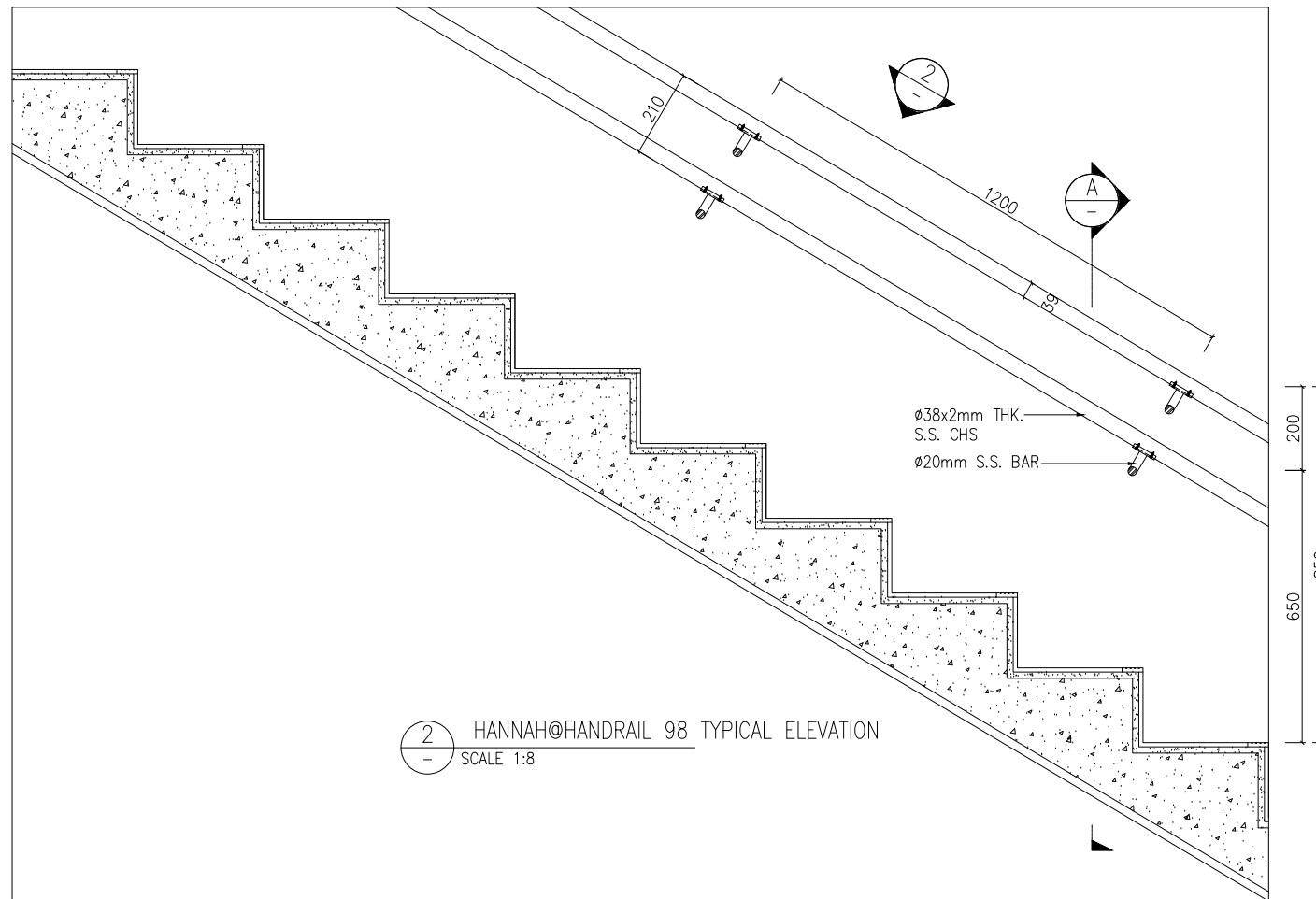

2 HANNAH@HANDRAIL 98 TYPICAL ELEVATION
SCALE 1:8

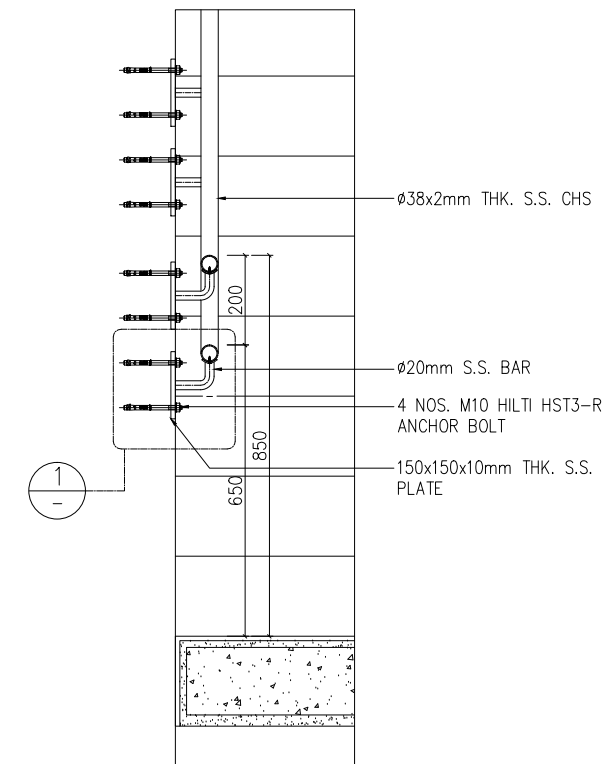

A SECTION
SCALE 1:8

Drawing Status :

Ref NO.:

Client

Management :

Supplier :

DIMON
Technology

DIMON Technology Ltd.

Tel: 00852-3916 5876

Fax: 00852-21203398

Http://www.dimontechnology.com

E-mail: gary@dimontechnology.com

Project:

Job Title:

HANNAH@HANDRAIL 98

Drawing Name:

RAILING
ELEVATION, PLAN AND DETAILS

Drawing NO.: RL-009

Drawing Scale: AS SHOW

Drawing Date: 2021/01/31

Drawing: Cai

Collate: Joyi

Auditing: Gray Hui

Drawing Version: 1