

Technical Drawing

T8 Batten

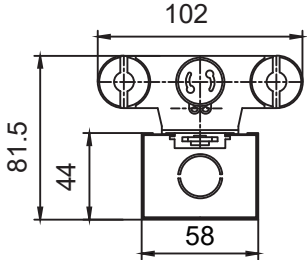

Twin Tube

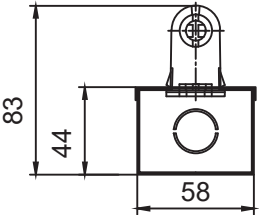

Single Tube

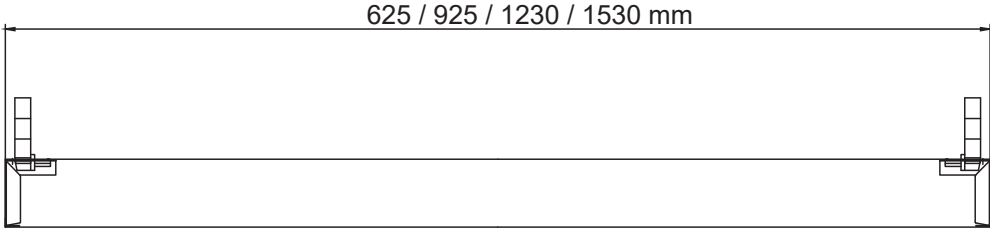

Polycarbonate Prismatic Diffuser

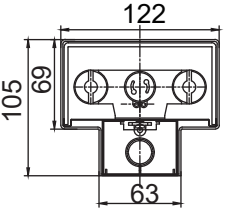

Twin Tube

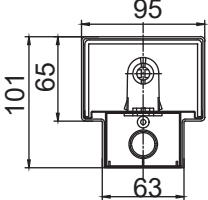

Single Tube

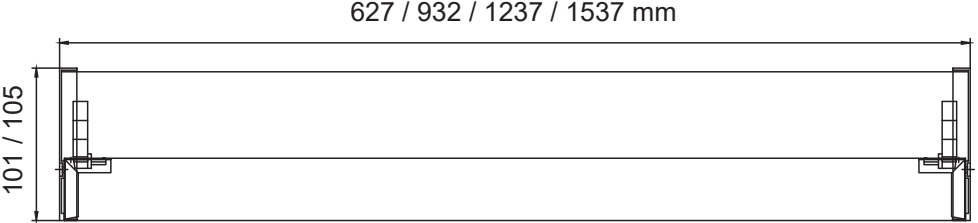

Unit: mm

Technical Drawing

T5 Batten

Metal Reflector V shape

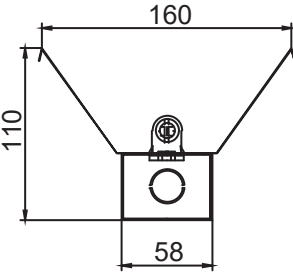

Single Tube
with reflector

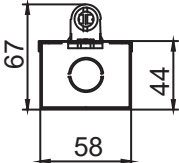

Single Tube

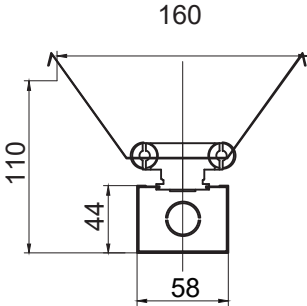
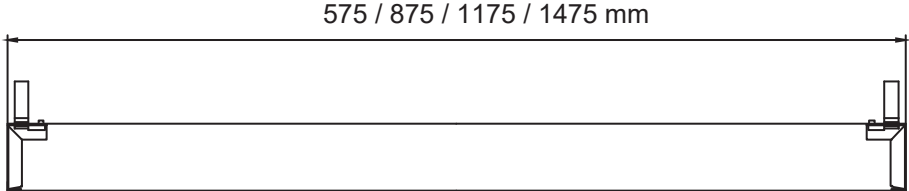

Twin Tube
with reflector

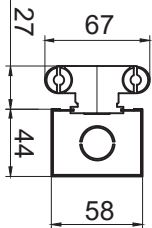

Twin Tube

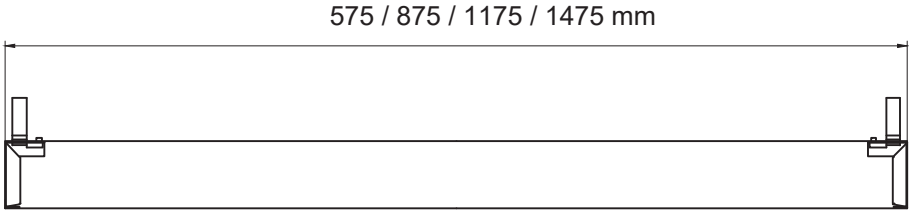

Unit: mm