

Technical Drawing

IP65 Protection

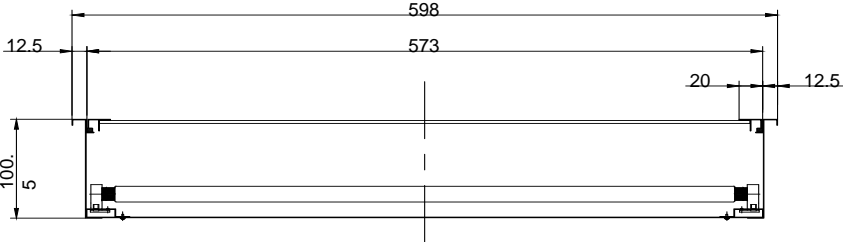

IP54 Protection

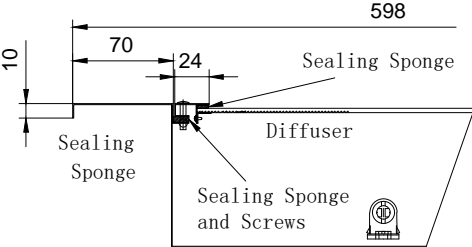
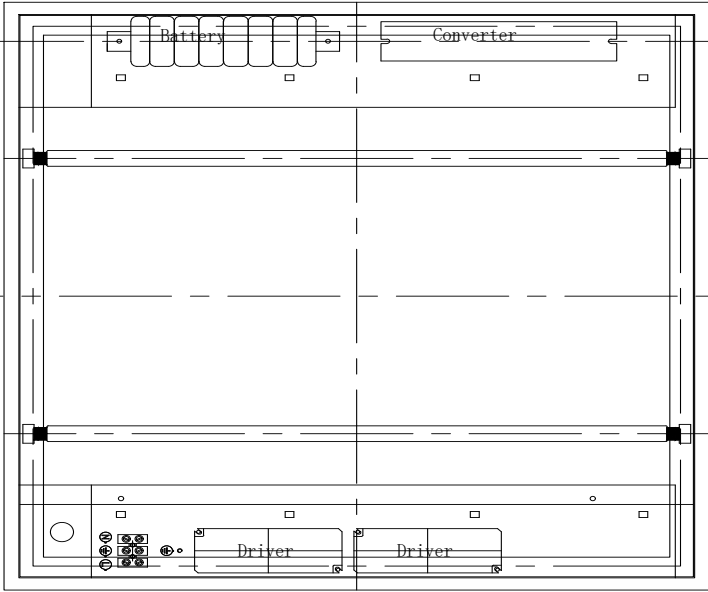
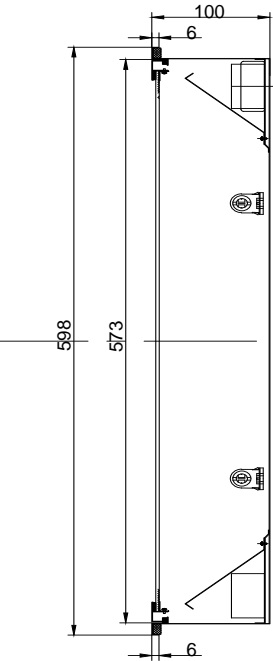
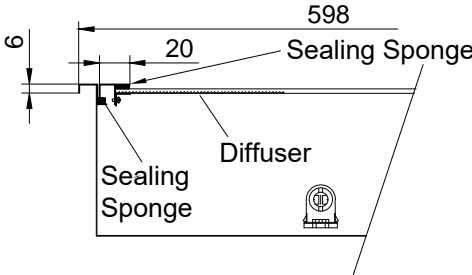

Cut-off: 580x580mm

Unit : mm

**Air-Tight Treatment for the clean room
ISO 14644-1 application**

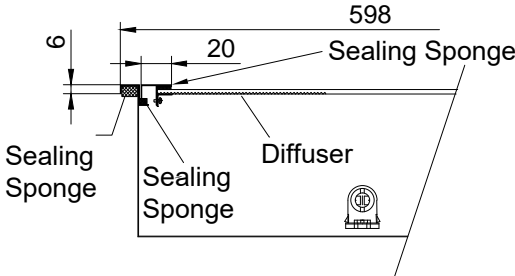

Technical Drawing

IP65 Protection

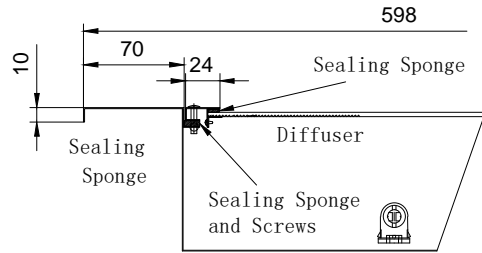

IP54 Protection

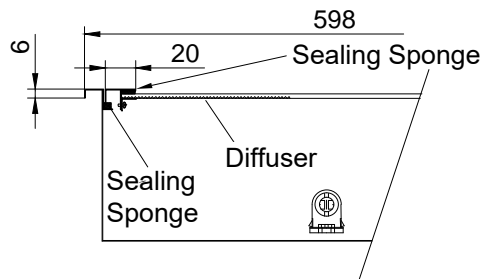

Air-Tight Treatment for the clean room ISO 14644-1 application

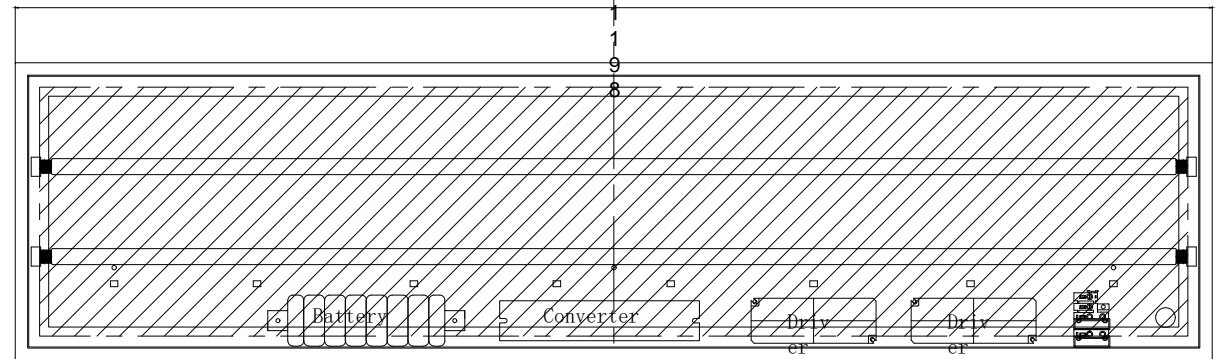
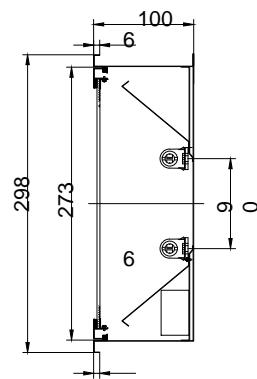
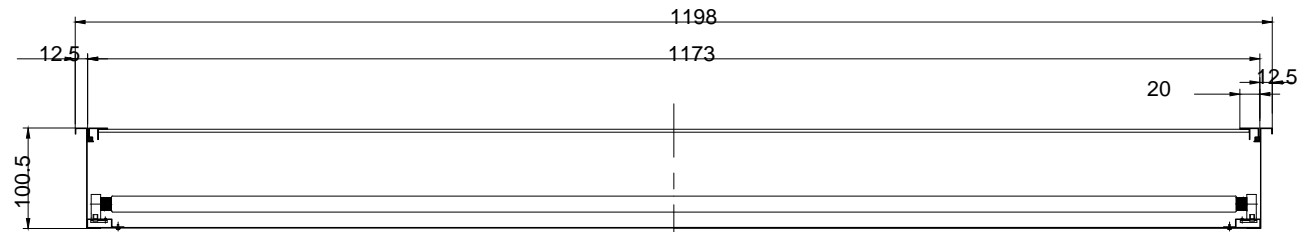
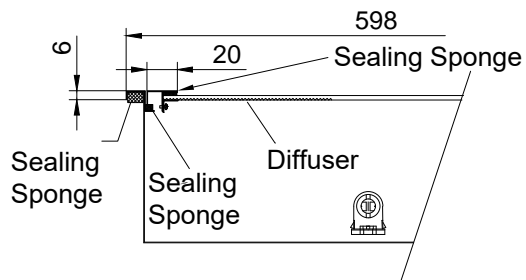

Cut-off: 280x1180mm

Unit : mm

Technical Drawing

IP65 Protection

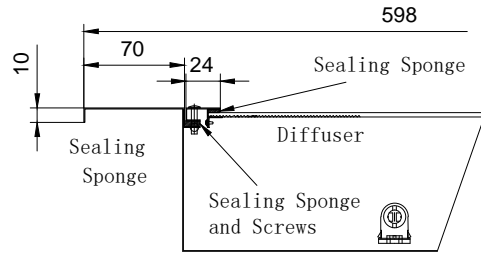

IP54 Protection

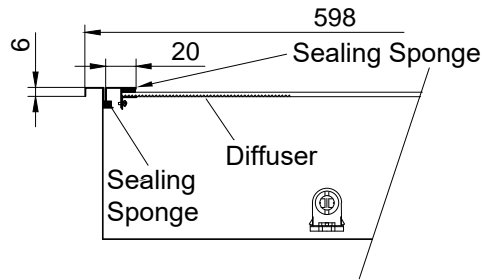

**Air-Tight Treatment for the clean room
ISO 14644-1 application**

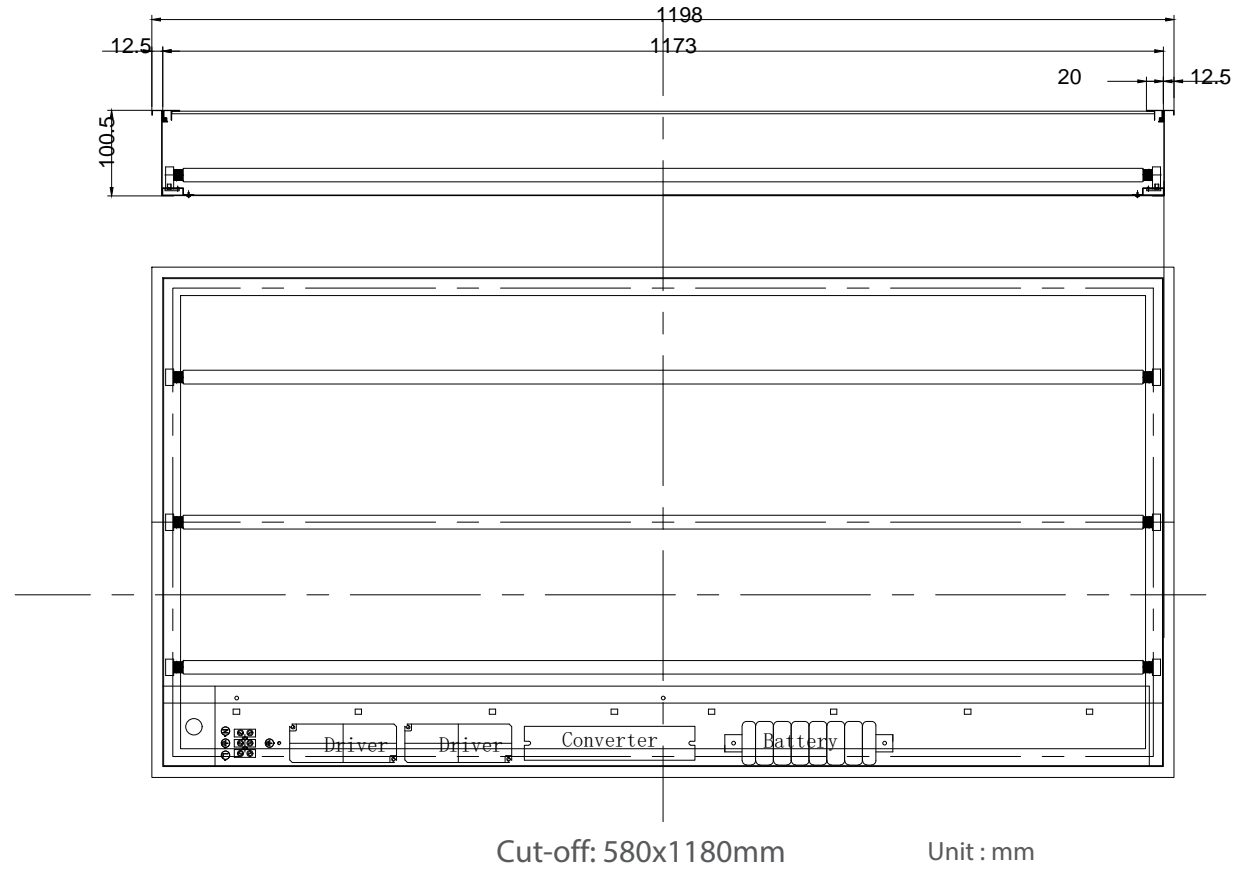
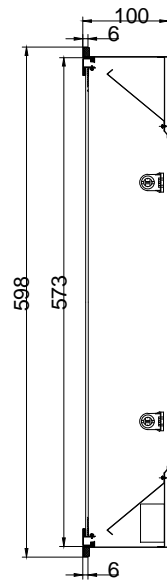
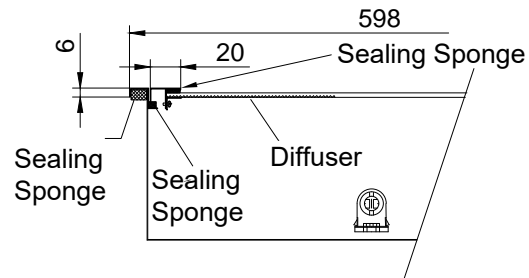

Technical Drawing-Air Slot Type

IP65 Protection

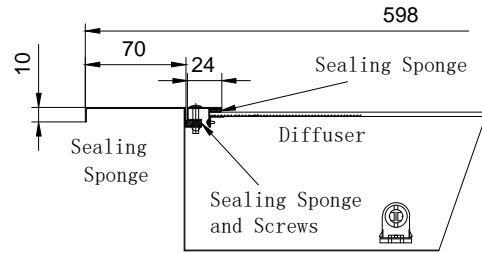

IP54 Protection

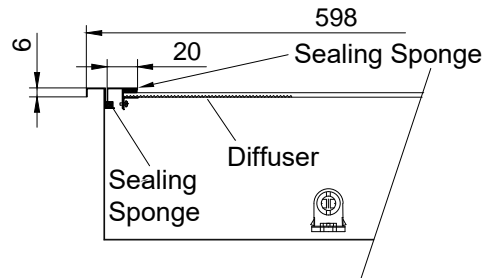

Air-Tight Treatment for the clean room ISO 14644-1 application

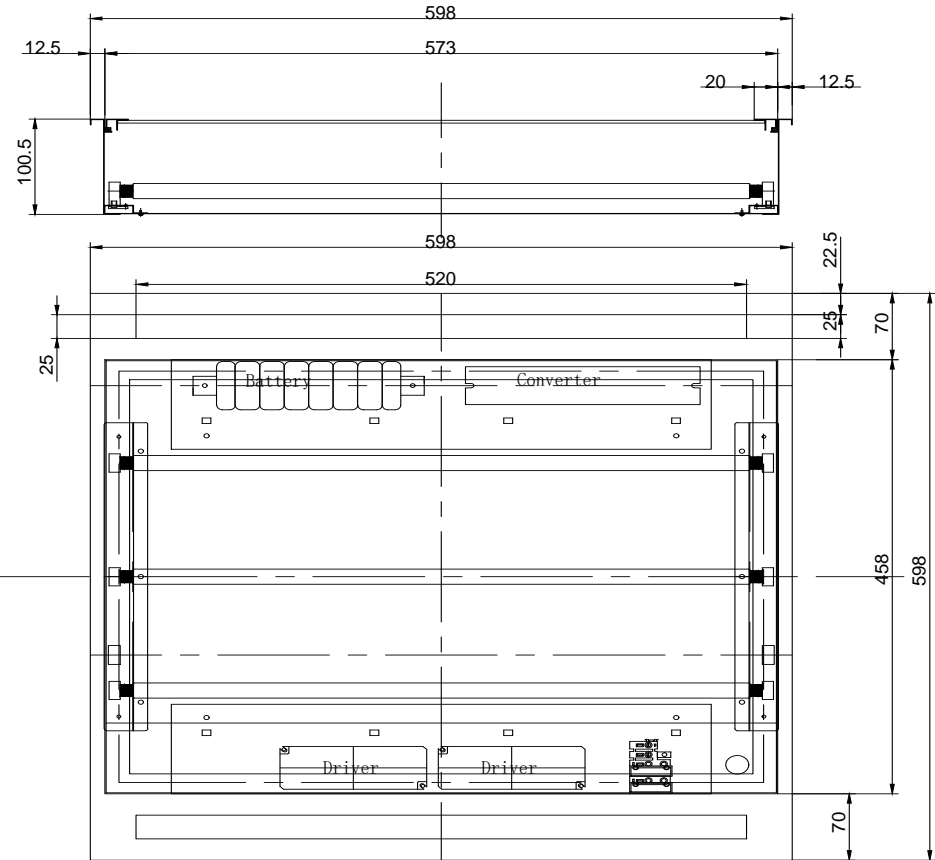
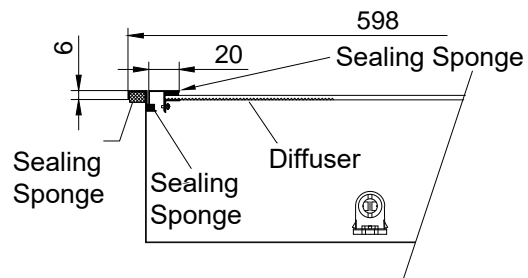

Cut-off: 580x580mm

Unit : mm

Technical Drawing-Air Slot Type (1 x LED T5 only)

IP65 Protection

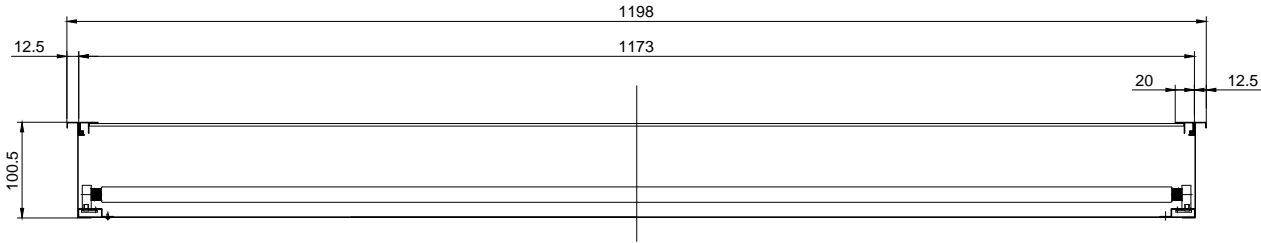
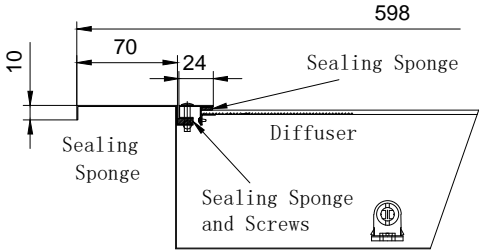

IP54 Protection

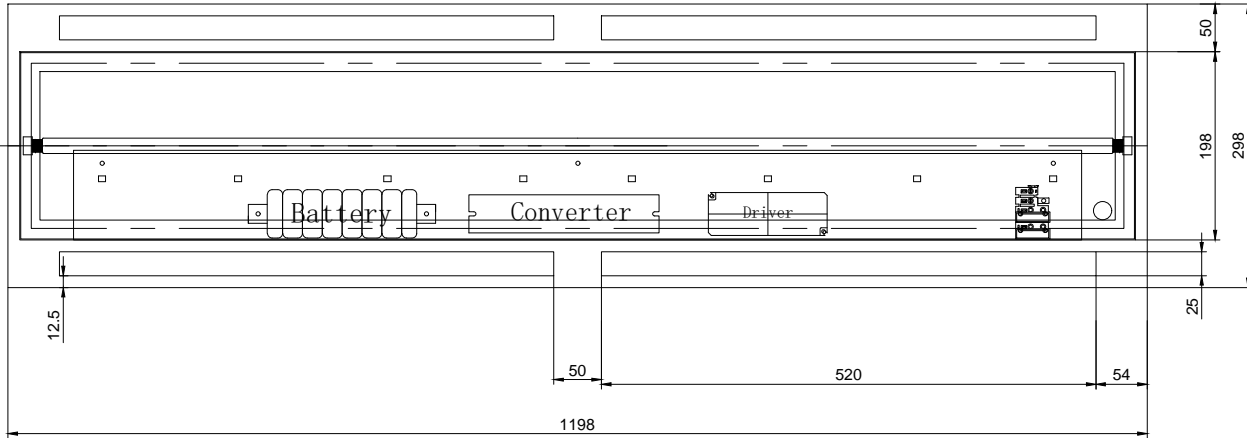
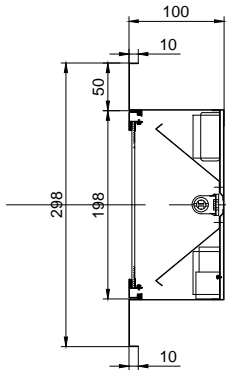
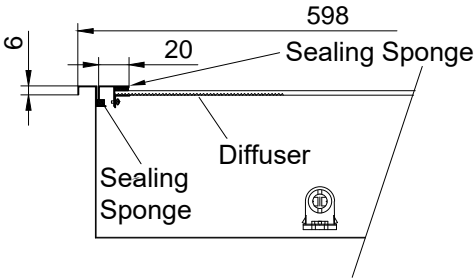

Air-Tight Treatment for the clean room ISO 14644-1 application

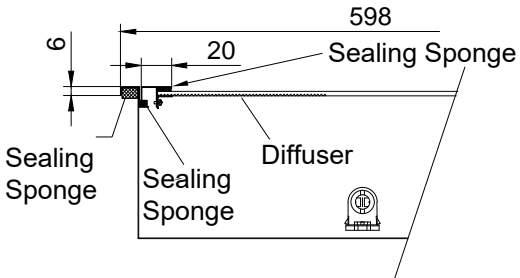

Cut-off: 280x1180mm Unit : mm

Technical Drawing-Air Slot Type

IP65 Protection

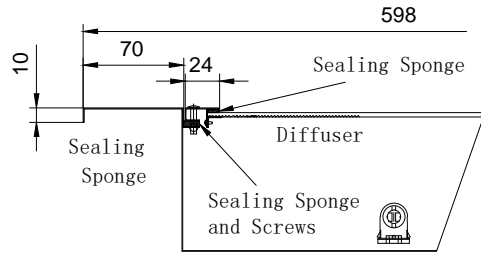

IP54 Protection

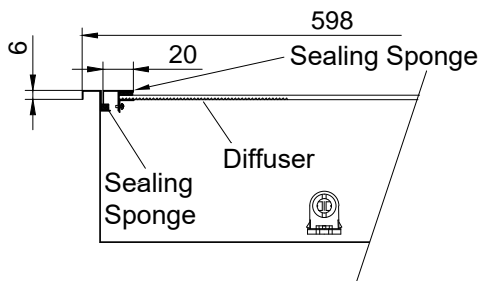

Air-Tight Treatment for the clean room ISO 14644-1 application

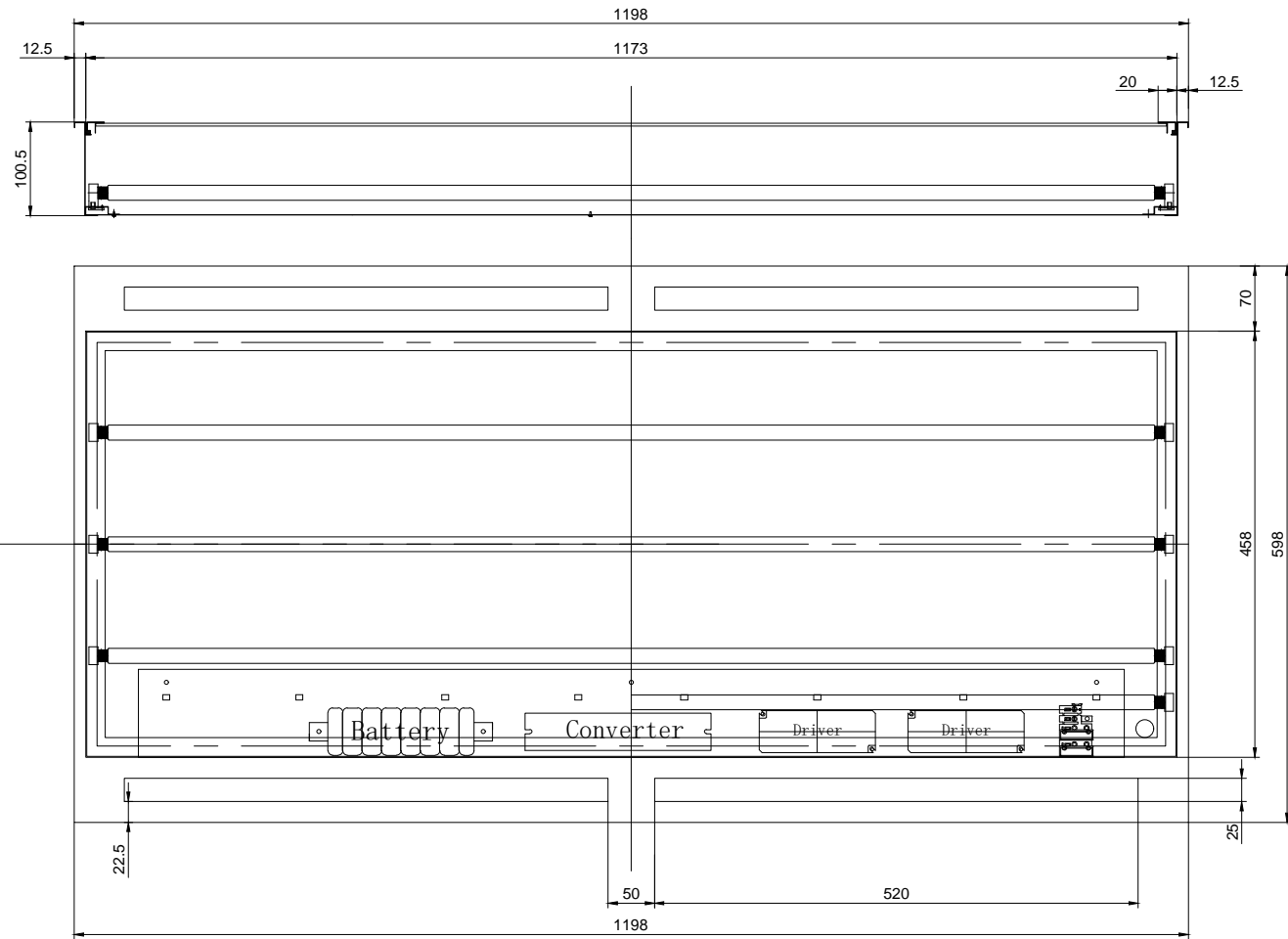
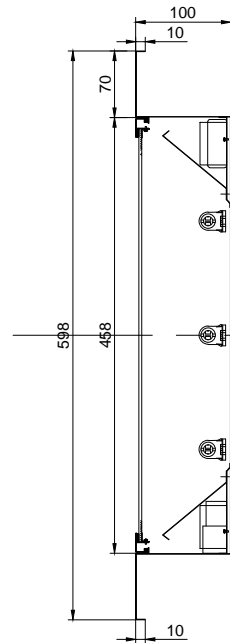
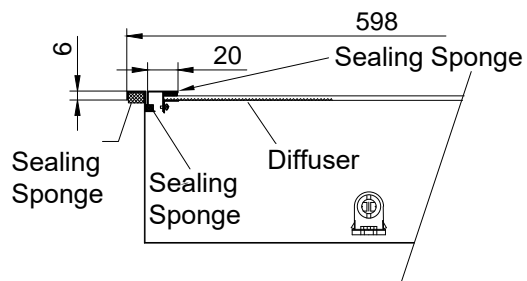

Cut-off: 580x1180mm

Unit : mm

Installation Instruction

1. Loosen the lamp cover

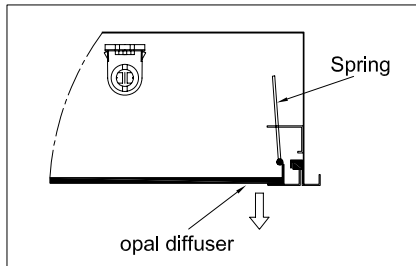

2. Power connection

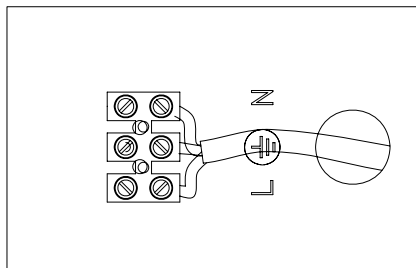

3. Putting tube into lampholder

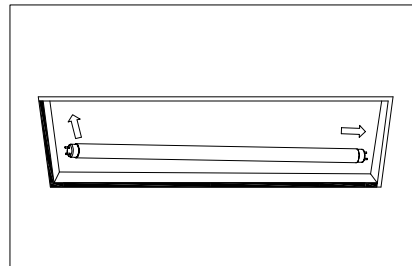

4. Lamp cover fixing

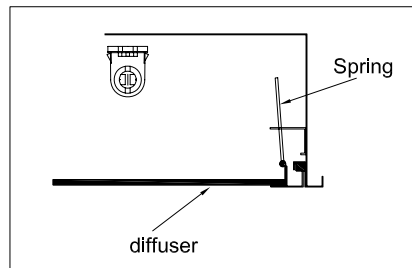

5. Fixture installation

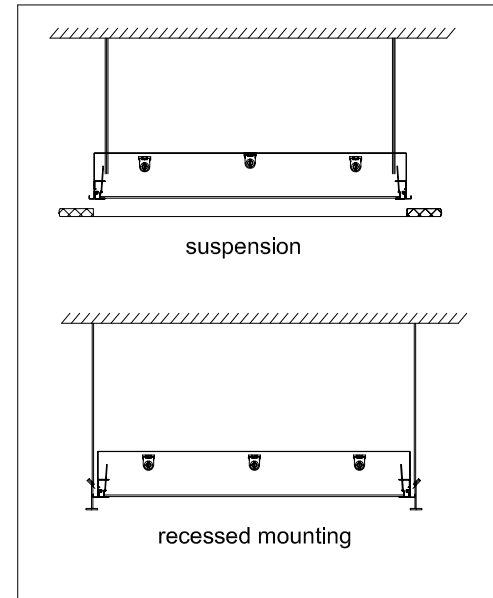

 CAUTION:

1. Use only bulbs comply with the specified voltage, frequency and wattage.
2. Always switch off before installing and switch on after installed properly.
3. Conform to the fire control clause when using this product.