

CHLOE -008

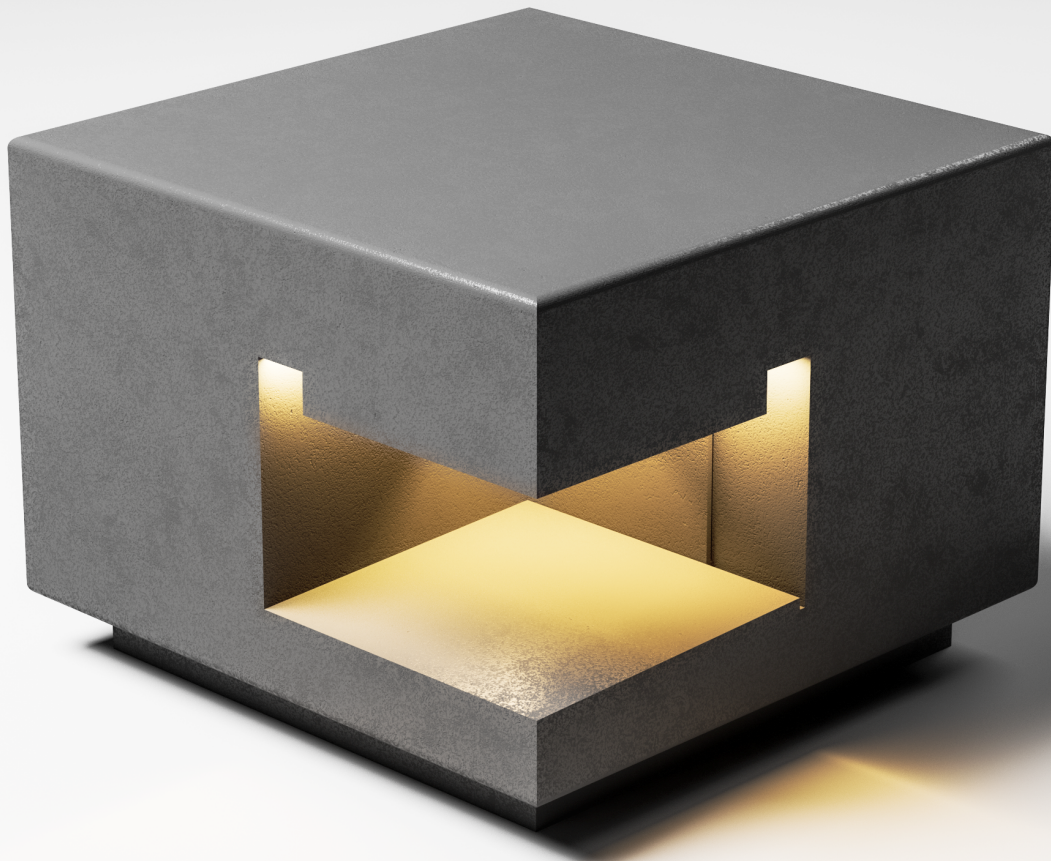

GRC Barrier Bench











- Materials: GRC Concrete Plinth
- Optional: Integrated IP67 LED Strip Light
- Polished Concrete Surface Finished
- Stainless steel anchoring accessories to floor or wall

CHLOE -008

GRC Barrier Bench

Technical Data

Materials	GRC Concrete Plinth
Finished	Polished Concrete Surface Finished
Optional	<p>Integrated IP67 LED Strip Light</p> <ul style="list-style-type: none">• Brand Name : DIMON Technology• Series Name: STECOR A• 12W/M Input Voltage: DC24 V• W: 12 x H: 5 mm• 240PCS 2835 Low Power LEDs @ 1 Meter Cutting Length: 25 mm• Color Temperature :2700K / 3000K / 4000K / 5000K / 6500K• CRI: >90 Beam Angle: 120°• MacAdam Ellipses Binning : Standard Deviation Colour Matching < 3 SDCM• Luminaire Efficacy: 100 Lm/w(2700K), 100 Lm/w(3000K), 120Lm/w(4000K), 130 Lm/w(5000K), 130 Lm/w(6500K),• Housing materials: Polyurethane (PU) Case and Polyurethane (PU) Glue• Ingress Protection: IP67• Remote-type LED Driver ON/OFF or Dali dimming or 0-10V Dimming• Comply Testing Standard: IEC 60598-1 / IEC 60598-2-1/ IEC 62471 / IEC 62493 / IEC 62031/ TM21 / ROHS/ EN 55015 / IEC 61000-3-2 /IEC 61347-1 /IEC 61347-2-13/IEC 61547
Installation accessories	Stainless steel anchor
Dimension	L:600x W 600x H450mm Detail refer to Technical Drawing-GRC Barrier Bench -008
Certification of LED Strip Light	        

Project	Fixture#	Date
		Firm



Ordering Information

Choose the option that suits your need and write its corresponding code on the appropriate line to form the product code.

Example product code:

CHLOE-008 - - _____
Type

Type	
Code	Description
A	Type A (with LED Strip Light)
B	Type B stainless steel anchoring to wall
C	Type C stainless steel anchoring to floor

Technical Drawing

Type B

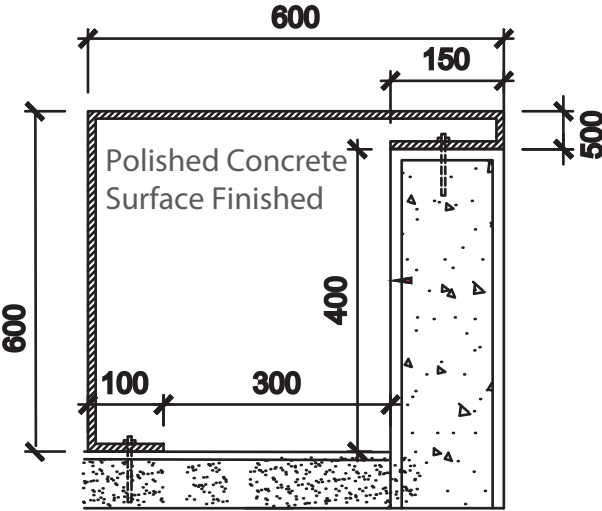

Type A
(with LED Strip Light)

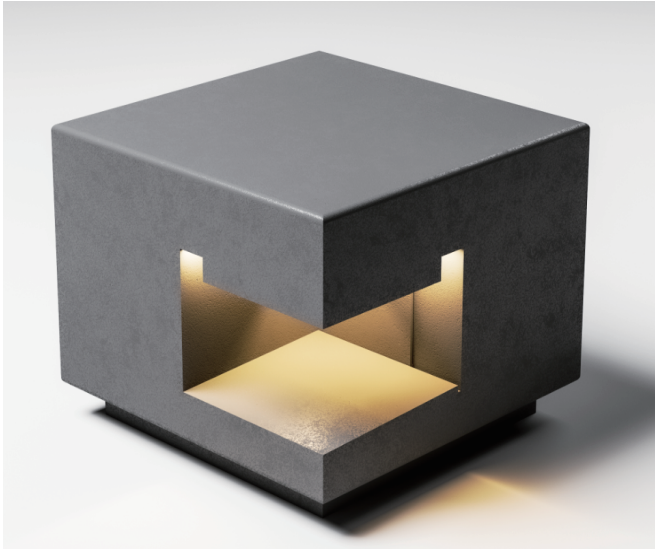
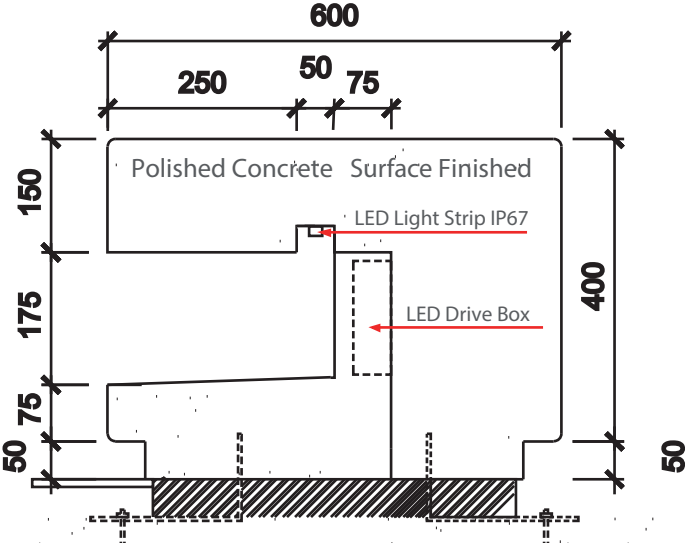

Type A
(with LED Strip Light)

Type C

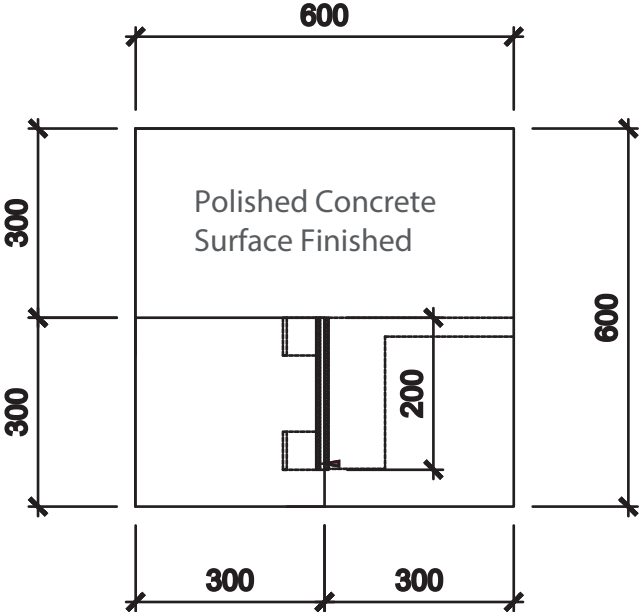
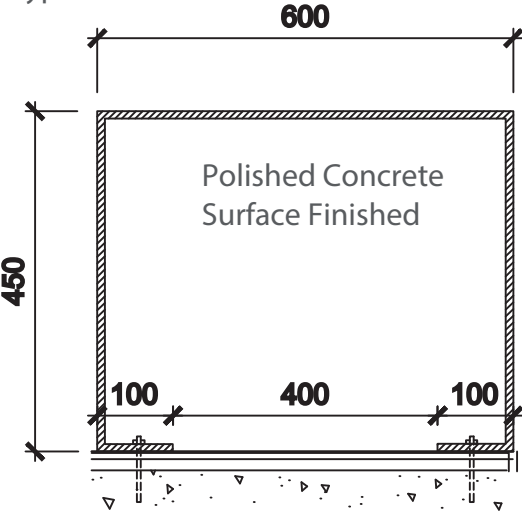

Plan Layout

Unit: mm