

DSAR Pro

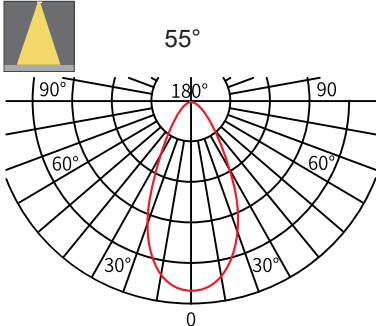

- LED OUTDOOR WALL LIGHT
- Housing: Extrusion aluminium housing with corrosion -resistance powder coating and die-cast aluminium cover.
- Anti-glare and high purity anodized aluminum reflector
- Tempered and safe glass and Screw-Less installation
- Ingress Protection: IP66 and Mech impact protection: IK08
- LED module: high-power CREE LEDs Array, CRI>80 or >95, LM-80 performance approval >50,000 hours.
- Integrated-Type ELV , 0-10V, DALI LED constant current control gear

BEAM ANGLE

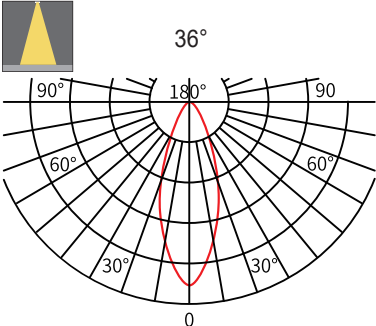
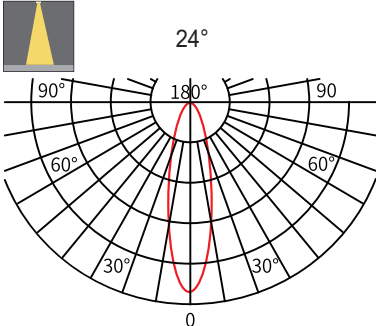
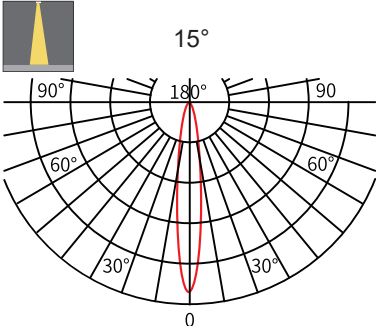

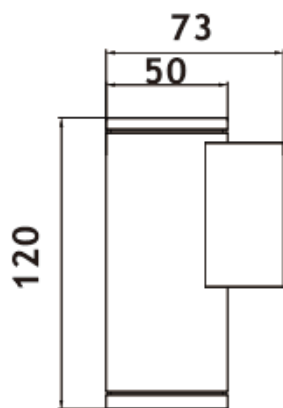

4W
up or down Light

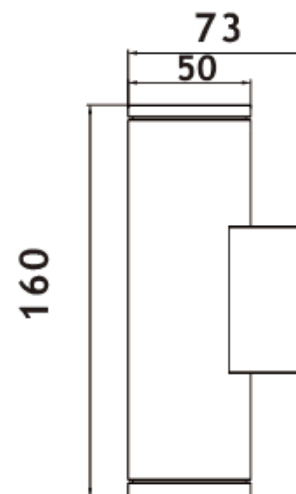

2 x 4W
up and down Light

ACCESSORIES



Visor 1

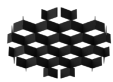

Honey comb

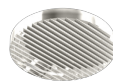

Striped Glass

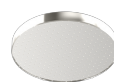

Frosted Softness



Visor II

Unit:mm

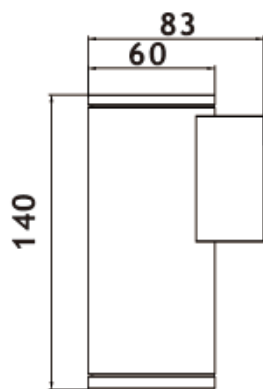

8W
up or down Light

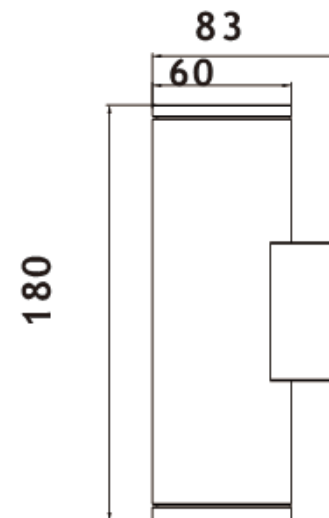

2 x 8W
up and down Light

ACCESSORIES



Visor 1



Honey comb

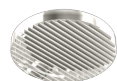

Striped Glass

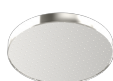

Frosted Softness



Visor II

Unit:mm

Technical Drawing

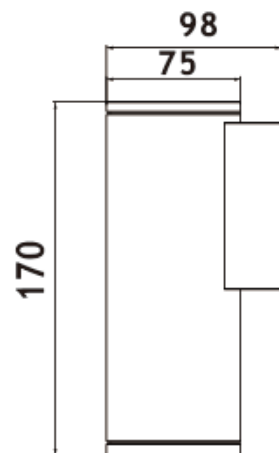

10W
up or down Light

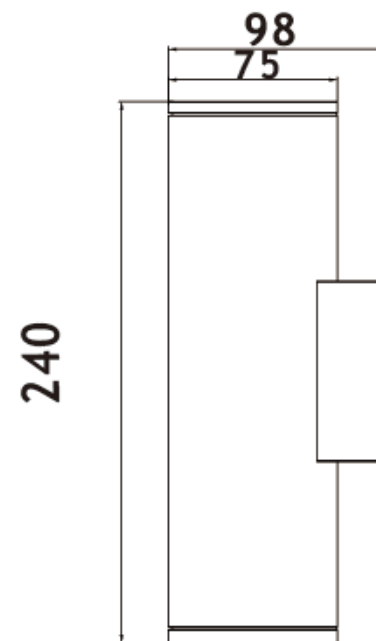

2 x 10W
up and down Light

ACCESSORIES



Visor 1



Honey comb

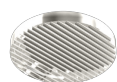

Striped Glass



Frosted Softness



Visor II

Unit:mm

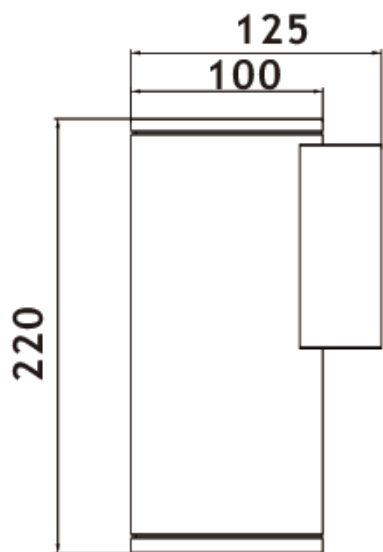

18W
up or down Light

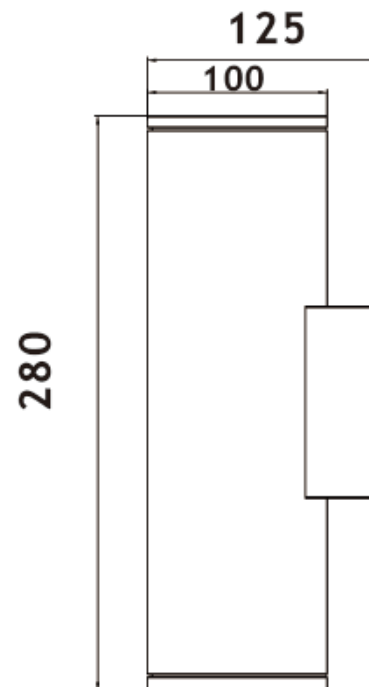

2 x 18W
up and down Light

ACCESSORIES



Visor 1

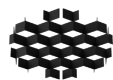

Honey comb

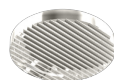

Striped Glass



Frosted Softness



Visor II

Unit:mm

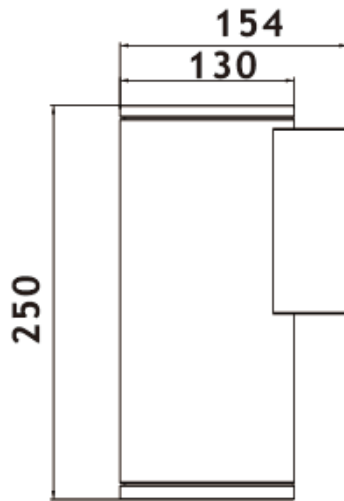

30W
up or down Light

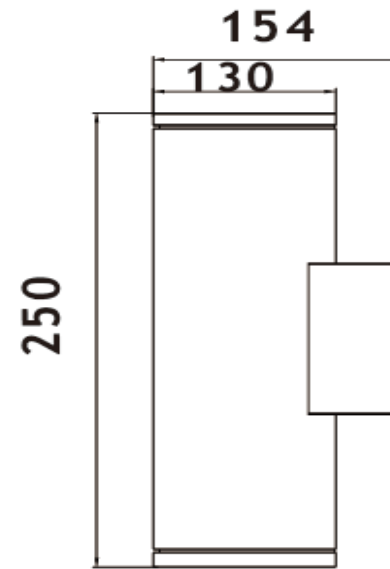

2 x 30W
up and down Light

ACCESSORIES



Visor 1

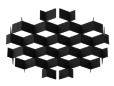

Honey comb

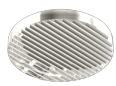

Striped Glass



Frosted Softness



Visor II

Unit:mm

Technical Drawing

