

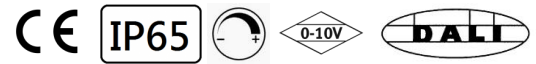





DSAY

75W Max IP65



Housing: die-cast aluminium, powder-coated, designed as heat sink. Anti-glare reflector and diffusor system made of PC. LED module: high-power CREE LEDs Array, CRI>90, LM-80 performance approval >50,000 hours. Integrated-Type ELV , 0-10V, DALI, DMX and RDM LED constant current control gear. IP65.

Technical Data

Luminaire Type-安裝方式Tipo de luminaria	Surface Mounted Type明裝式燈具Superficie Tipo Montado						
Dimension-尺寸-Dimensión	<ul style="list-style-type: none"> • Dia 125 x H: 145 mm • Dia 165 x H: 190 mm • Dia 200 x H: 230 mm 						
QTY of LEDs-燈珠數量-CANT de LEDs	1 pcs CREE LED Array						
Power Consumption Max-燈具功率 Consumo de energía Max	<ul style="list-style-type: none"> • 28W@ Dia 125mm • 36W@ Dia 125mm • 41W@ Dia 125mm @ Dia 165mm • 60W@ Dia 165mm @ Dia 200mm • 75W@ Dia 200mm 						
Input Voltage-輸入電壓-Voltaje de entrada	AC220-240V 50/60HZ						
LED Driver Type LED驅動款式 Tipo de controlador LED	<p>Integrated-type LED Driver--Refer to LED driver specification 請參閱LED驅動器規格 Consulte la especificación de controlador de LED</p> <ol style="list-style-type: none"> 1. ON/OFF Switch AC220-240V 50/60HZ 2. ELV Dimming Driver (5-100%) AC 100-120V 50/60Hz or AC 200-240V 50/60HZ 3. 0-10V Dimming Driver AC100-240V 50/60HZ 4. Dali Dimming Driver AC100-240V 50/60HZ 5. DMX Driver AC100-240V 50/60HZ 6. RDM Driver AC100-240V 50/60HZ 7. Emergency Backup >2 hours or >3 hours @ < 24 charger hours應急電池/Copia de seguridad de emergencia 						
LED Driver Features 驅動特性 Funciones del controlador de LED	<p>POWER FACTOR : PF>0.90 @ Full Load TOTAL HARMONIC DISTORTION: THD< 20% EFFICIENCY (Typ.): >85% MAX. No. of PSUs on 16A CIRCUIT BREAKER: 25 units (circuit breaker of type B) / 40 units (circuit breaker of type C at 230VAC)</p>						
Control Protocol-控制協議 Protocolo de Control	0-10V / Dali / DMX 512 / RDM / ZIGBEE Wireless Control						
Beam Angle光東角ángulo de haz	15° 24° 36° 55°						
Light Source Brand-光源品牌-Fuente de luz de marca	CREE (Photobiological safety-IEC 62471 'Risk Group 1' (low risk))						
"Lumen Maintenance LM-80 Reported by TM-21"	<ol style="list-style-type: none"> 1. L90(10k) = 50,700 hrs 2. L80(10k) > 63,500 hrs 3. L70(10k) > 63,500 hrs 						
LED Life-LED壽命-La vida del LED	>60,000 hours						
Color Temperature -色溫 Temperatura del color	2700K / 3000K / 4000K / 5000K / 6500K						
Color Rendering Index-顯色指數 Índice de reproducción cromática	<ul style="list-style-type: none"> • > 80 • > 90 						
MacAdam Ellipses Binning 麥克亞當橢圓分級 Mac Adam binning ellipse	<p>Standard Deviation Colour Matching < 3 SDCM 標準偏差配色 < 3 SDCM Coincidencia de color estándar Desviación < 3 SDCM</p>						
Luminaire Efficacy 燈具效率 La eficacia de la luminaria	<table> <tr> <td>85 Lm/w(2700K),</td> <td>85 Lm/w((3000K),</td> <td>90 Lm/w((4000K),</td> </tr> <tr> <td>100 Lm/w((5000K),</td> <td>100 Lm/w((6500K),</td> <td></td> </tr> </table>	85 Lm/w(2700K),	85 Lm/w((3000K),	90 Lm/w((4000K),	100 Lm/w((5000K),	100 Lm/w((6500K),	
85 Lm/w(2700K),	85 Lm/w((3000K),	90 Lm/w((4000K),					
100 Lm/w((5000K),	100 Lm/w((6500K),						
LED Source Luminous Efficacy LED光源光效 Fuente luminosa LED Eficacia	<table> <tr> <td>125 Lm/w(2700K),</td> <td>125 Lm/w((3000K),</td> <td>130 Lm/w((4000K),</td> </tr> <tr> <td>140 Lm/w((5000K),</td> <td>140 Lm/w((6500K),</td> <td></td> </tr> </table>	125 Lm/w(2700K),	125 Lm/w((3000K),	130 Lm/w((4000K),	140 Lm/w((5000K),	140 Lm/w((6500K),	
125 Lm/w(2700K),	125 Lm/w((3000K),	130 Lm/w((4000K),					
140 Lm/w((5000K),	140 Lm/w((6500K),						
Housing materials-外殼材料 Materiales de la carcasa	<p>Die-cast aluminum and Polycarbonate 壓鑄鋁和PC Aluminio fundido a presión y policarbon</p>						
Housing Color 外殼顏色 color de la carcasa	<p>Powder Coating :Matte white body and Matte Black body 粉末塗料：啞光白和啞光黑 Recubrimiento en polvo: cuerpo blanco mate y cuerpo negro mate</p>						
Ingress Protection-防護等級 Protección de ingreso	IP65 - (IEC 60529)						
Environment-使用環境-medio ambiente	Outdoor						
Operating Humidity -工作濕度 Humedad de funcionamiento	0~90%, non-condensing-不結霜 sin condensación						
Operating Temperature Range / 工作溫度範圍 Rango de temperatura de funcionamiento	-30 °C / +50 °C						
Comply Testing Standard 符合測試標準 Cumplir el estándar de prueba	<p>LED Luminaires: IEC 60598-1 / IEC 60598-2-1/ Photometric data-IES format LED Driver: EN 55015 / IEC 61000-3-2 /IEC 61347-1 /IEC 61347-2-13/IEC 61547</p>						
Certification-認證-Certificación	    						

Project	Fixture#	Date
		Firm



Ordering Information

Choose the option that suits your need and write its corresponding code on the appropriate line to form the product code.

Example product code: [DSAY-75W](#)

DSAY - - _____
Power Consumption

Power Consumption	
Code	Description
28W	28W@Dia 125mm
36W	36W@Dia 125mm
41W	41W@Dia 125mm@Dia 165mm
60W	60W@Dia 200mm
75W	75W@Dia 200mm

BEAM ANGLE

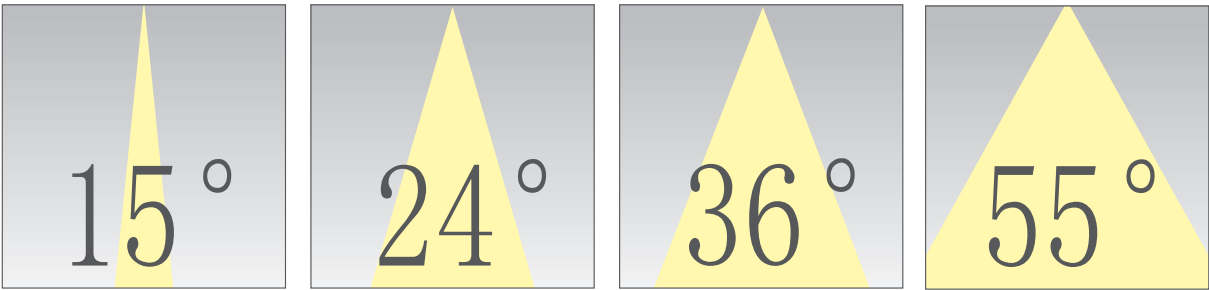

Technical Drawing

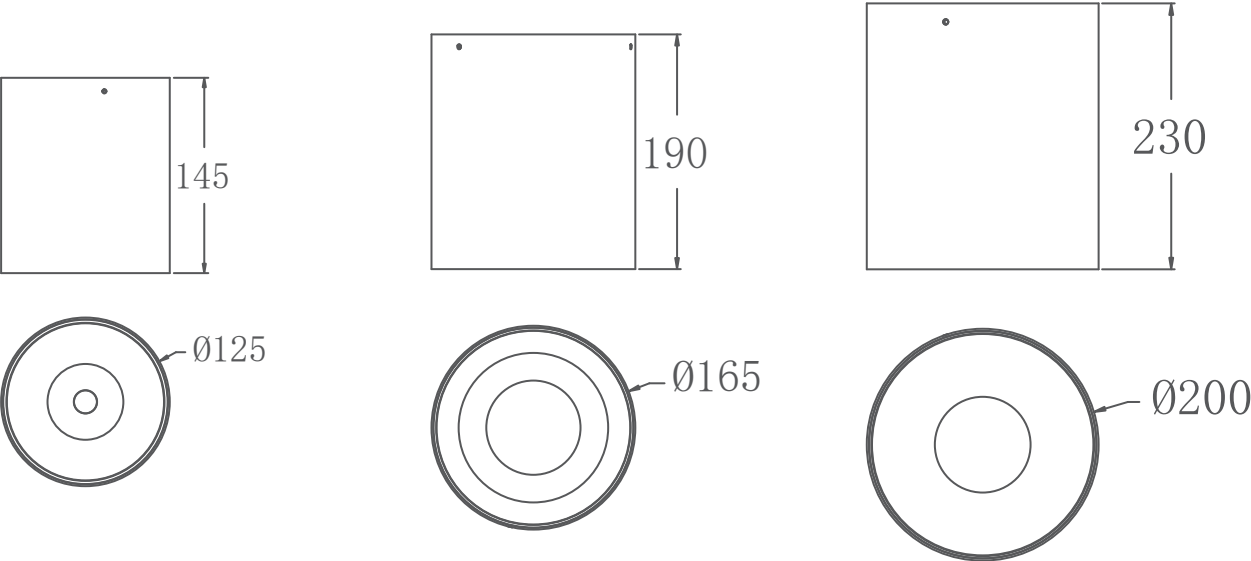

Unit: mm