

F-SPAMY (ZOOM)

ZOOM Range 15° -60°

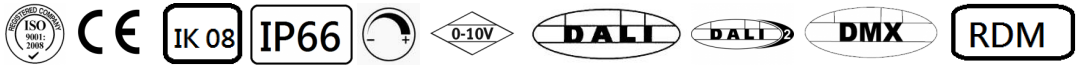

RAL7046 Grey



RAL9017 Traffic Black



RAL6025 Fern Green



RAL9003 Signal White











- Spolt Zoomable Projector Light -ZOOM Range 15° -60°
- Special housing designs and high-quality optical components specifically for demanding visual tasks to provide enhanced visual comfort.
- Discreet and compact aesthetically designed architectural outdoor spotlight,ideal for glare-free accent lighting,floodlighting and wall washing in the outdoor area.

F-SPAMY (ZOOM)

ZOOM Range 15° -60°

DIMON
TECHNOLOGY

Technical Data

Installation Method / 安裝方式 Metodo de instalacion	Surface Mounted and Adjustable Type / Spike Mounted / Tree Mounted / Pole Mounted 表面安裝和可調型/釘裝/樹裝/桿裝 Montado en superficie y tipo ajustable / Montado en púas / Montado en árbol / Montado en poste
Optical Accessories / 光學配件 Accesorios ópticos	Honeycomb Louver / Cylindrical Hood / Cylindrical Hood Angle 45° 蜂巢百葉窗/圓柱形罩/圓柱形罩角度 45° Rejilla de panal / capó cilíndrico / ángulo de capó cilíndrico 45°
Rotation angle / 旋轉角度 Ángulo de rotación	Vertical : 180° Horizontal : 355°
Power Consumption with LED Driver LED燈具包括LED驅動電源功率 Consumo de energía con controlador de LED	• 10W with Gear Loss 2W • 12W with Gear Loss 2W • 15W with Gear Loss 2W
Input Voltage / 輸入電壓 Voltaje de entrada	220-240VAC 50-60HZ 24VDC / 48VDC
LED Driver Type LED驅動款式 Tipo de controlador LED	Integrated-type LED Driver--Constant Current LED Driver: Refer to LED driver specification 請參閱LED驅動器規格 Consulte la especificación de controlador de LED 1. ON/OFF Switch AC220-240V 50/60HZ 2. DC 24V / DC 458 3. 0/1 -10V Dimming Driver AC220-240V 50/60HZ 4. DALI Dimming Driver AC220-240V 50/60HZ 5. DMX Driver AC220-240V 50/60HZ (Dimming range from 0-100%) 6. Remoted Type Emergency Backup >2 hours
Power Factor / 功率因數/Factor de potencia	PF>0.9
Total Harmonic Distortion/總諧波失/Distorsión armónica total	THD<20%
Light Source Brand-光源品牌-Fuente de luz de marca	CREE
"Lumen Maintenance LM-80 Reported by TM-21"	L70(10k) > 54,000 hrs
LED Life-LED壽命-La vida del LED	>100,000 hours
Color Temperature and Color 色溫 and 顏色 Temperatura y color del color	2700K 3000K 4000K 5000K 6500K
Color Rendering Index-顯色指數 Índice de reproducción cromática	>80 >90
MacAdam Ellipses Binning 麥克亞當橢圓分級 Mac Adam binning elipse	Standard Deviation Colour Matching < 3 SDCM 標準偏差配色< 3 SDCM Coincidencia de color estándar Desviación < 3 SDCM
Beam Angle/光束角/ángulo de haz	Zoom Range 15° to 60°
Luminaire Efficacy 燈具效率 La eficacia de la luminaria	80 Lm/w(2700K) 80 Lm/w(3000K) 80 Lm/w(4000K) 85 Lm/w(5000K) 85 Lm/w(6500K)
LED Source Luminous Efficacy LED光源光效 Fuente luminosa LED Eficacia	120 Lm/w(2700K) 130 Lm/w(3000K) 140 Lm/w(4000K) 150 Lm/w(5000K) 150 Lm/w(6500K)
Housing materials 外殼材料 Materiales de la carcasa	Die-Casted Aluminium and Aluminium Alloy and Tempered Glass 壓鑄鋁和鋁合金及鋼化玻璃 Aluminio fundido a presión y aleación de aluminio y vidrio templado de
Housing Color外殼顏色 color de la carcasa	Traffic Black RAL9017 / 黑 RAL9017 / Negro RAL9017 Signal white RAL9003 / 白 RAL9003 / Blanco RAL9003 Telegrey 2 RAL7046 / 灰 RAL7046 / Gris tele 2 RAL7046
Ingress Protection-防護等級 Protección de ingreso	IP66
Mech impact protection 機械衝擊保護 Protección contra impactos mecánicos	IK08
Operating Temperature Range / 工作溫度範圍 Rango de temperatura de funcionamiento	-20 °C / +50 °C
Storage Temperature 儲藏溫度 Temperatura de almacenamiento	-40 °C / +70 °C
Operating Humidity -工作濕度 Humedad de funcionamiento	0~90%, non-condensing-不結霜 sin condensación
Dimension尺寸Dimensión	Dia 85 x H: 125mm with Surface mount Bracket H: 162mm Dia 85 x H: 125mm with Spike mount Bracket H: 427mm
Certificate Standard Complied 符合安規標準 estándar certificado de cumplimiento	LED Luminaries: IEC / EN 60598-1;IEC/EN 60598-2-1; IEC TR62778 IEC62471 (RG1); IEC 62031; EN62493 RoHS LED Driver: IEC/EN 61347-1; IEC/EN 61347-2-13; IEC/EN 62384; IEC/EN 61000-3-2; IEC/EN 61000-3-3;IEC/EN61574;EN 55015
Certification-認證-Certificación	        

Project	Fixture#	Date
		Firm

Ordering Information

Choose the option that suits your need and write its corresponding code on the appropriate line to form the product code.

Example product code: [F-SPAMY-15W](#)

F-SPAMY

- _____
POWER
CONSUMPTION

POWER CONSUMPTION	
Code	Description
10W	10W
12W	12W
15W	15W

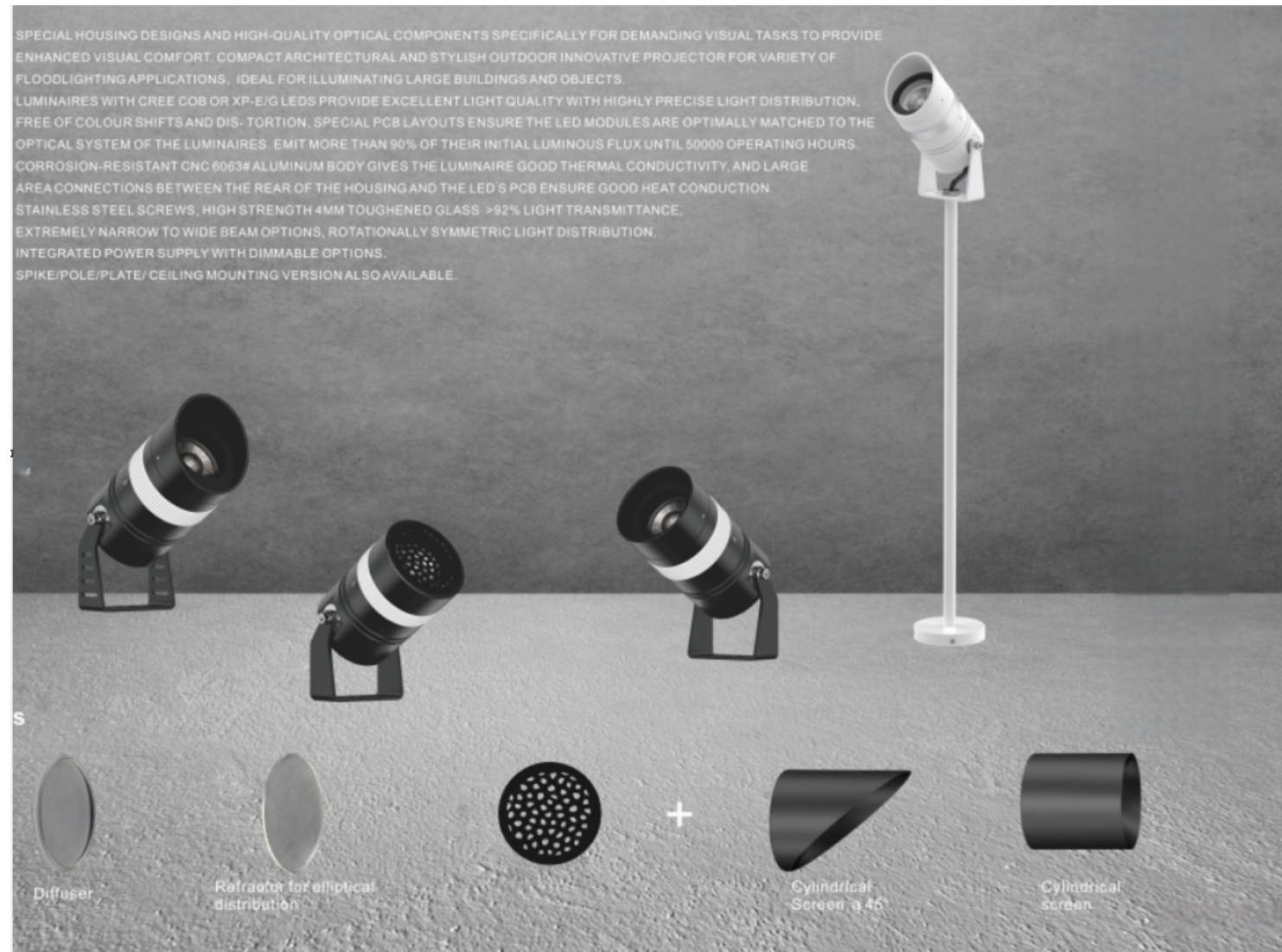

Technical Drawing

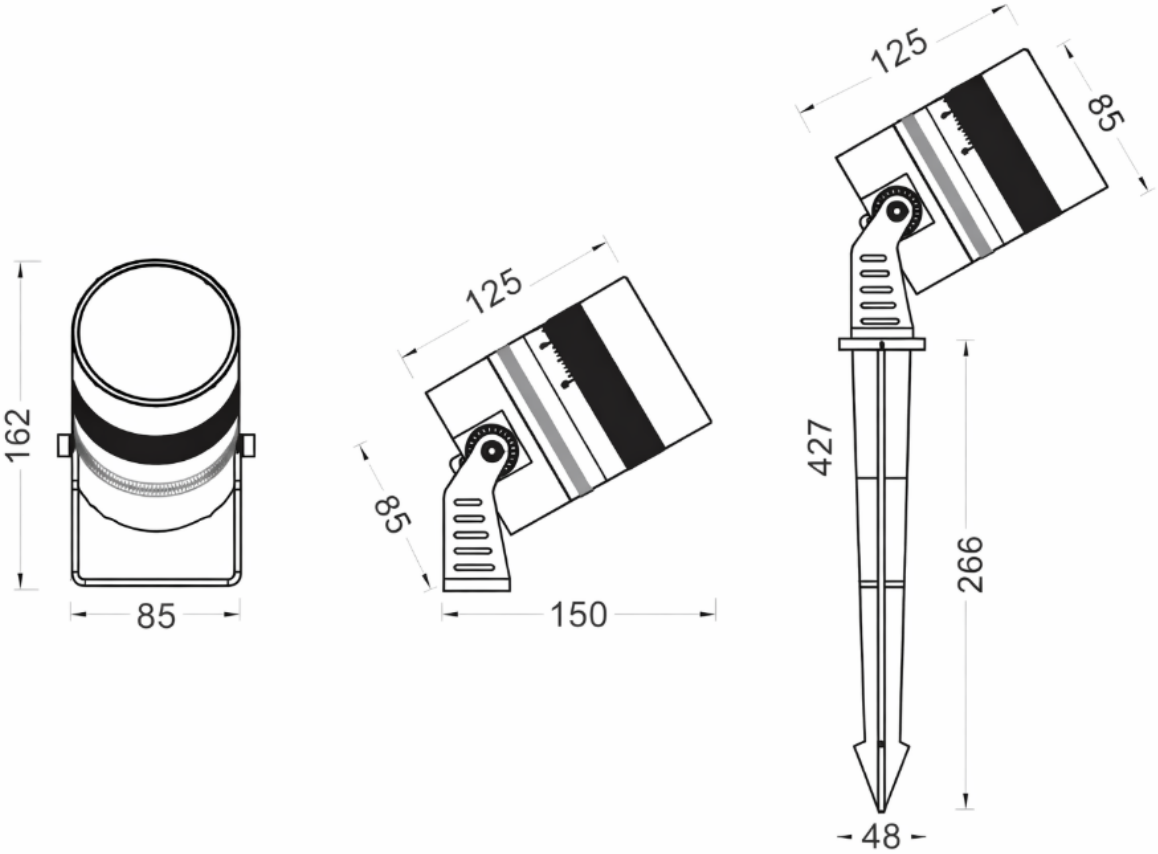

Unit: mm