



GALOIS -Solar

Solar Led Garden Light 60W Max

IK 08 **IP65**

Anti UV Prism PC diffuser

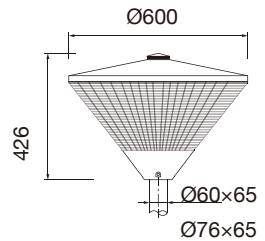

Anti UV Clear PC Diffuser

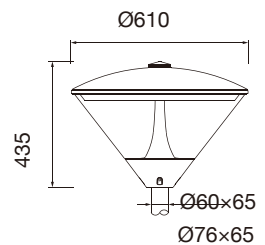



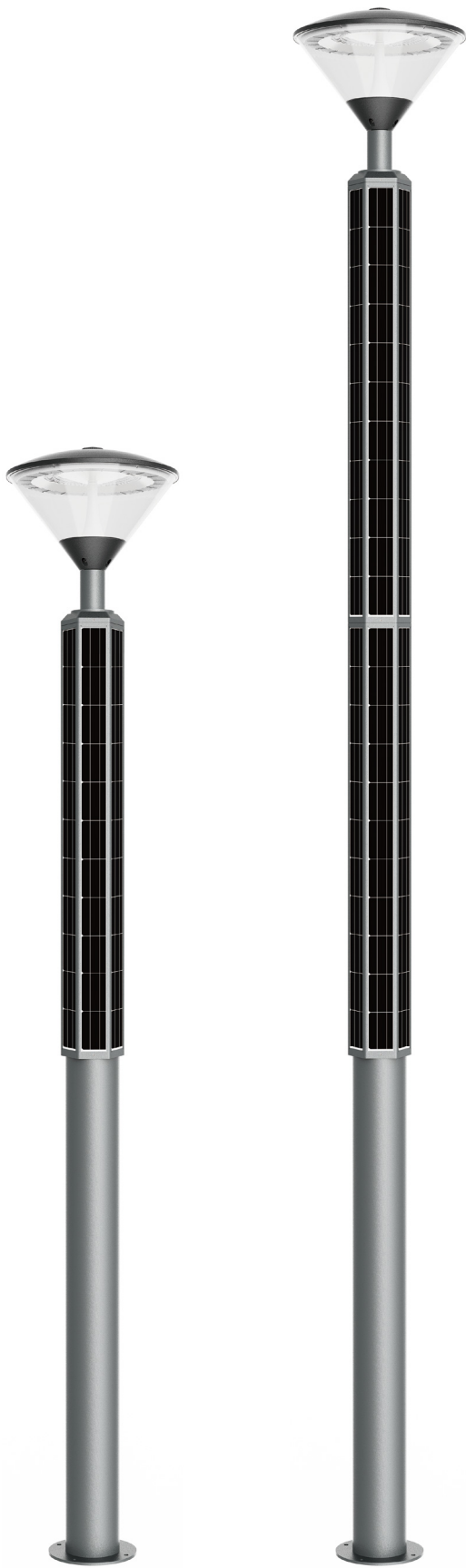

160W mono-crystalline
Solar PV Module



- All-in-one -Professional design to combine solar panel, light source, controller, battery as one.
- Built-in the modular LiFePo4 battery in the pole system
- 160W Monocrystalline solar PV Module efficiency up to 22.8%
- Programmable MPPT for Timing dimming output to achieve energy-saving
- Mains Complementary Solar Controller : Charge over the power source from mains supply when solar energy is out of running

Technical Data

LED Rated Power	30W 60W
Solar Panel Power / 太陽能電池板功率 Energía del panel solar	160W @ 30W LED Rated Power 320W @ 60W LED Rated Power
Photovoltaic Cell Type / 光伏電池類型 Tipo de celda fotovoltaica	Monocrystalline Silicon
Photovoltaic / 光伏效率 Eficiencia fotovoltaica	Up to 24%
Type of battery / 電池類型 / tipo de batería	LiFePO4 Battery
Battery Capacity / 電池容量 Capacidad de la batería	12.8V 30Ah@ 30W LED Rate Power 12.8V 60Ah@ 60W LED Rate Power
Battery Location / 電池位置 Ubicación de la batería	Inside of pole
Solar Controller / 太陽能控制器 Controlador solar	Programmable MPPT
AC Hybrid Version / 交流混合版 Versión híbrida de CA	Optional : No or Yes
Charge Time / 充電時間 / tiempo de carga	8 Hours (By Bright Sunlight)
Discharge Time / 放電時間 Tiempo de descarga	3 Days Max
Dimming profile parameters (Factory Preset) 調光配置文件參數 (工廠預設) Dimming profile parameters (Factory Preset)	First 3 hours from dusk: luminaire at 100% brightness Next 6 hours: luminaire at 30% brightness Next (until dawn): luminaire at 40% brightness
Color Temperature / 色溫 Temperatura del color	3000K / 4000K / 5000K / 5700K
Color Rendering Index / 顯色指數 Índice de reproducción cromática	> 80
Luminaire Efficiency / 燈具光效 Eficiencia de la luminaria	100 Lm/w(3000K) 100 Lm/w(4000K) 110 Lm/w(5000K) 110 Lm/w(5700K),
Light Distribution / 光分佈 Distribucion de luz	Asymmetric T2A T3A T4A T1 T32B
Housing materials / 外殼材料 Materiales de vivienda	Lantern: Die-casting aluminium body, PC transparent diffuser Pole: Q355 high-strength structural steel
Housing Color / 外殼顏色 / Color de la carcasa	LED Lantern : Polyester powder Black RAL 9005; Grey RAL 9006; White RAL 9003; Traffic Grey RAL 7042 Pole: Hot Dip Galvanized and Polyester powder Black RAL 9005; Grey RAL 9006; White RAL 9003; Traffic Grey RAL 7042
Ingress Protection / 防護等級 / Protección de ingreso	IP65
Mech impact protection / 機械衝擊防護 LED Lantern	IK08
Dimension / 尺寸 / Dimensión	Refer to drawing
Operating Temperature Range / 工作溫度範圍 Rango de temperatura de funcionamiento	30 °C / +50 °C
Certification	   

Project	Fixture#	Date
		Firm



Ordering Information

Choose the option that suits your need and write its corresponding code on the appropriate line to form the product code.

Example product code: GALOIS-30W

GALOIS - _____
POWER

POWER	
Code	Description
30W	30W
60W	60W

BEAM ANGLE

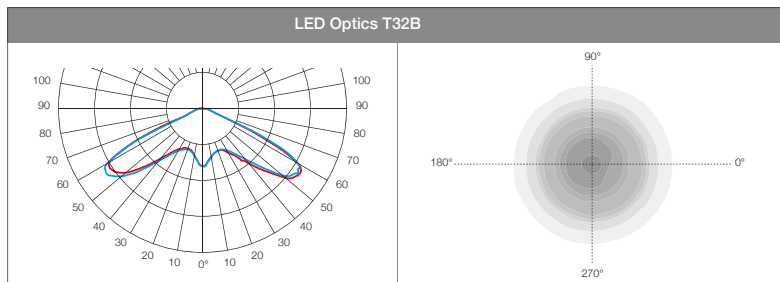
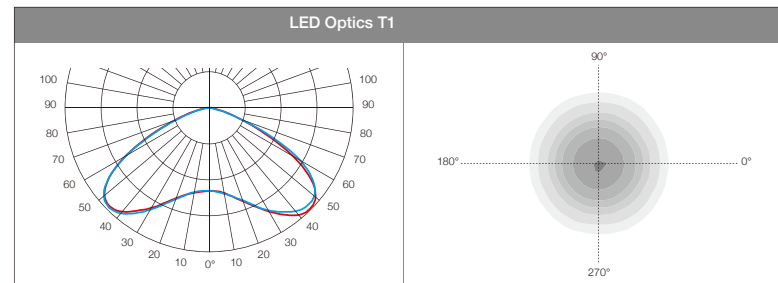
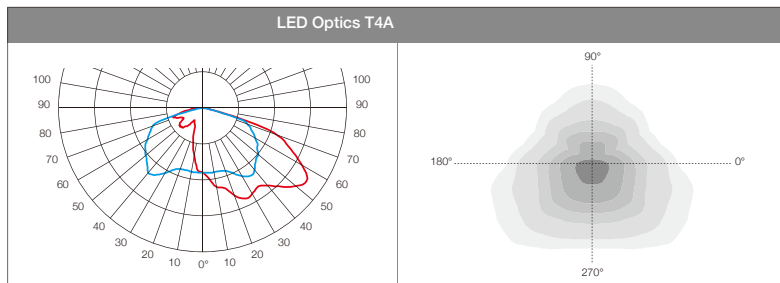
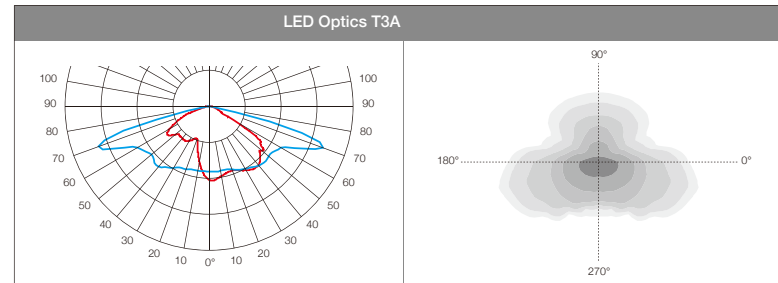
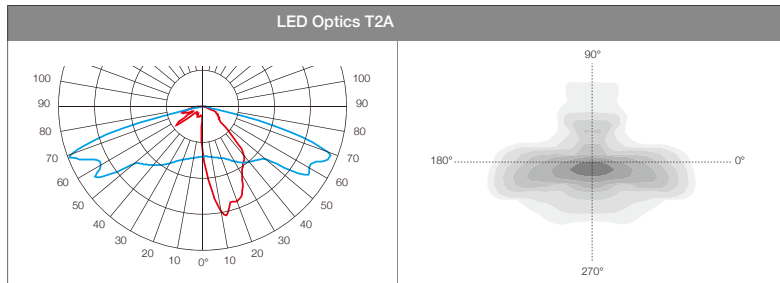

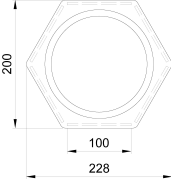
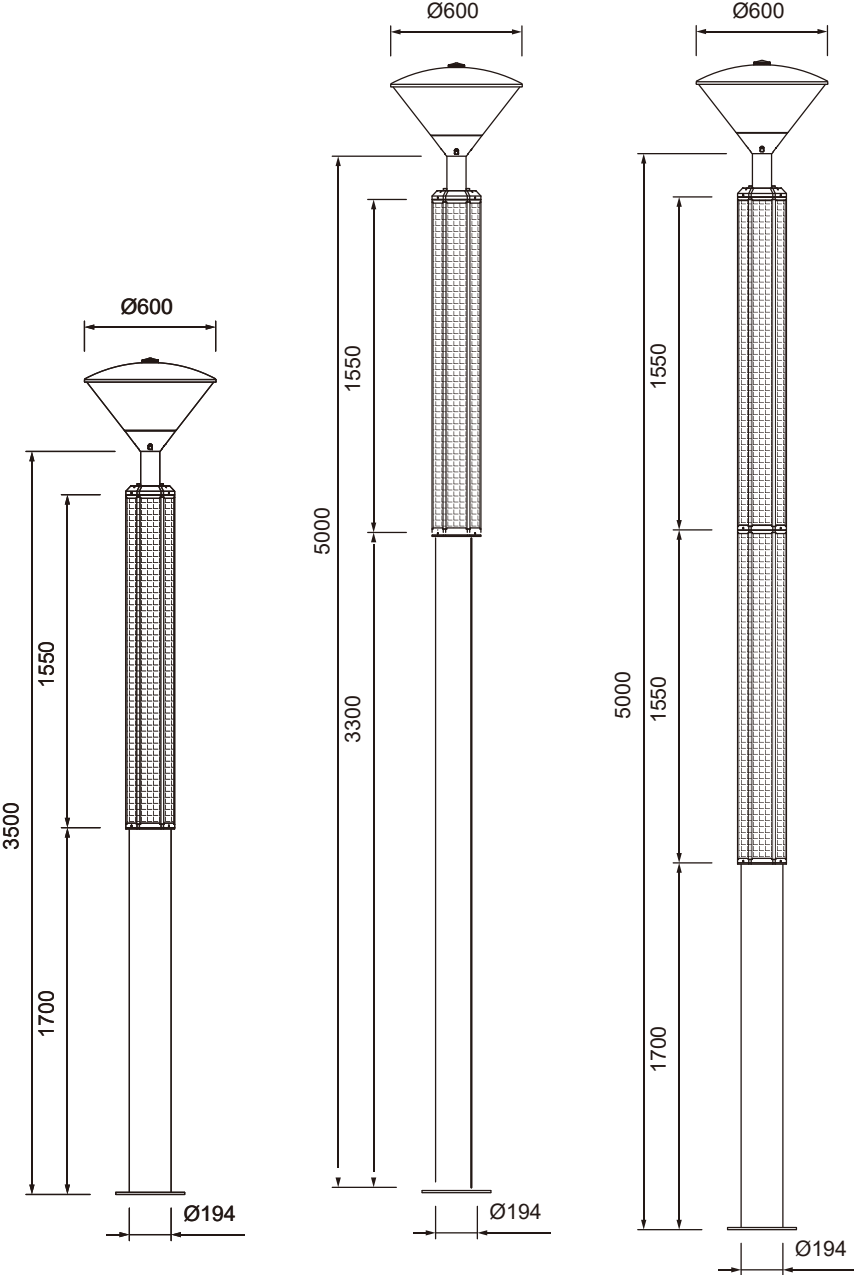

Solar PV Module
160W mono-crystalline silicon

Unit: mm