

LABITY-VICTOR

L: 1140 W:220xH:93mm UGR19









- Suspended /Ceiling surface mounted luminaire with aluminum alloy structure integrated with advanced side light transmittance technology, direct and indirect light illuminating, high transmitting optical light guide PMMA plate create shadow free and uniform light output without any glare.
- Advanced thermal management technology to ensure consistency of LED life span, color temperature and maximize output lumens.
- Applications: Offices, schools, hospitals, hotels, shopping malls, public buildings, airport halls etc

Technical Data

Luminaire Type-安裝方式 Tipo de luminaria

Suspended Mounted-吊裝-Suspendido montado Suspension Wire--Length: 1000mm
Ceiling surface mounted -吸頂安裝 Montado en la superficie del techo

Dimension-尺寸-Dimensión LxWxH	1140*220*93mm		
Power Consumption with LED Driver LED燈具包括LED驅動電源功率 Consumo de energía con controlador de LED	25W	30W	36W
LED Driver Type LED驅動款式 Tipo de controlador LED	Integrated -type LED Driver--Constant Current LED Driver Refer to LED driver specification 請參閱LED驅動器規格 Consulte la especificación de controlador de LED • ON/OFF Switch AC220-240V 50/60HZ • 1-10V Dimming Driver AC100-240V 50/60HZ • Dali Dimming Driver (1-100%)AC100-240V 50/60HZ		
LED Driver Features Constant Current LED Driver: 驅動特性-恆流LED驅動器 Funciones del controlador de LED	POWER FACTOR : PF>0.90 @ Full Load TOTAL HARMONIC DISTORTION: THD< 20%		
Control Protocol/控制協議/Protocolo de Control	1-10V or Dali		
Light Source Brand-光源品牌-Fuente de luz de marca	OSRAM		
"Lumen Maintenance LM-80 Reported by TM-21"	L70 > 60,000 hrs		
LED Life-LED壽命-La vida del LED	>60,000 hours		
Color Temperature -色溫 Temperatura del color	2700K / 3000K / 4000K / 5000K / 6000K / 6500K		
Color Rendering Index-顯色指數 Índice de reproducción cromática	>85		
Photobiological safety-EN 62471 / of Luminaire 光生物安全檢驗(EN 62471) 结果: Seguridad fotobiológica-EN 62471	Exempt 豁免(無危險) Eximir		
MacAdam Ellipses Binning 麥克亞當橢圓分級 Mac Adam binning ellipse	Standard Deviation Colour Matching < 3 SDCM 標準偏差配色< 3 SDCM Coincidencia de color estándar Desviación < 3 SDCM		
Beam Angle 光束角 ángulo de haz	Up and Down Light 180° UGR : 19		
Luminaire Efficacy燈具效率 La eficacia de la luminaria	80 Lm/w(2700K) 100 Lm/w(5000K)	80Lm/w(3000K) 100 Lm/w(6500K)	90 Lm/w(4000K) 100 Lm/w(6500K)
LED Source Luminous Efficacy LED光源光效Fuente luminosa LED Eficacia	130 Lm/w(2700K) 150 Lm/w(5000K)	130Lm/w(3000K) 150 Lm/w(6500K)	140 Lm/w(4000K)
Housing materials-外殼材料 Materiales de la carcasa	High-quality Aluminum alloy with PMMA Diffuser 鋁合金和PMMA 擴散器 Aleación de aluminio de alta calidad con difusor de PMMA		
Housing Color外殼顏色color de la carcasa	Electrostatic thermo-painting Silver 電熱塗銀 Termopintura electrostática Plata		
Ingress Protection-防護等級 Protección de ingreso	IP40		
Operating Temperature Range / 工作溫度範圍 Rango de temperatura de funcion ambiente	-30 °C / +50 °C		
Comply Testing Standard 符合測試標準 Cumplir el estándar de prueba	LED Luminaries: LVD: IEC/EN 60598-1;EN / IEC/EN 60598-2-1;IEC62471;IEC/EN 62031; IEC/EN 62493 ; IEC/EN 62471 LED Driver: IEC 61347-1; IEC 61347-2-13; IEC 62384; IEC 61000-3-2; IEC 61000-3-3;IEC61574;EN 55015 ; IEC 62384		
Certification-認證-Certificación	     		

Project	Fixture#	Date
		Firm

Ordering Information

Choose the option that suits your need and write its corresponding code on the appropriate line to form the product code.

Example product code: [LABITY-36W](#)

LABITY - _____
POWER CONSUMPTION

POWER CONSUMPTION	
Code	Description
25W	25W
30W	30W
36W	36W

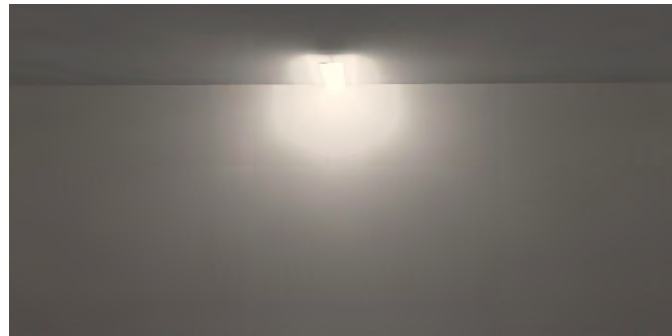

Details



Beam Angle

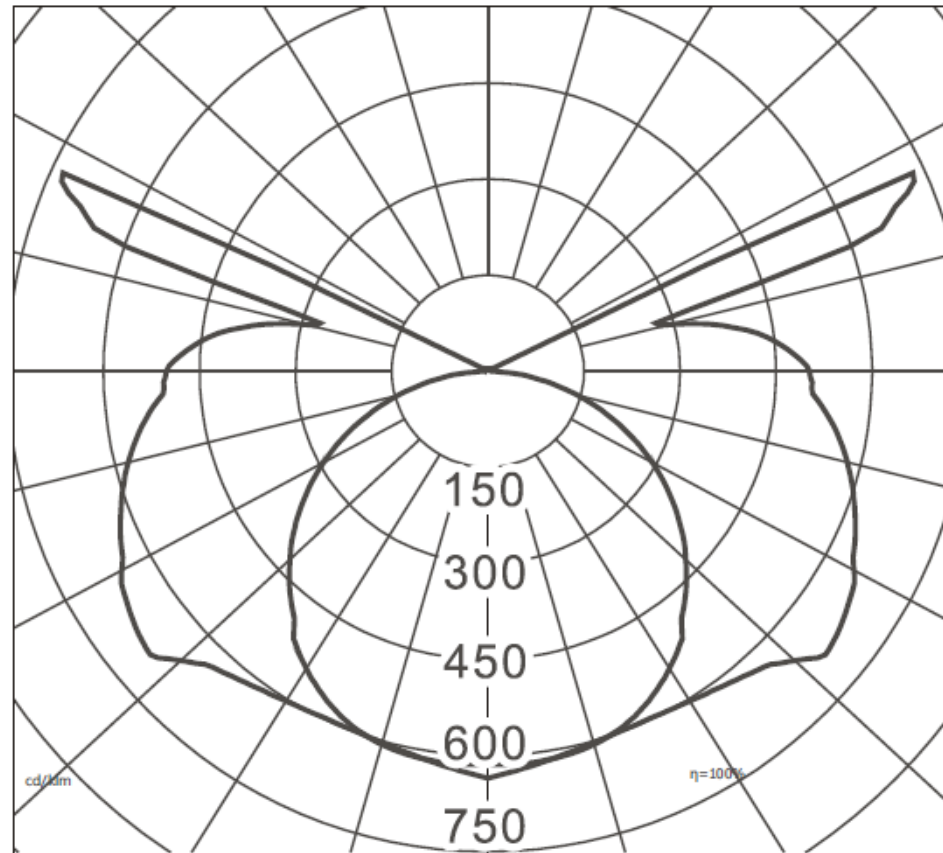

Technical Drawing

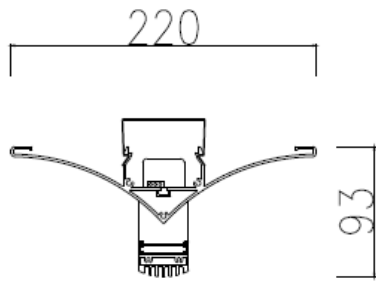

Installation:
Ceiling Mounted

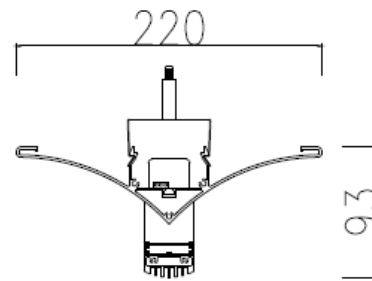
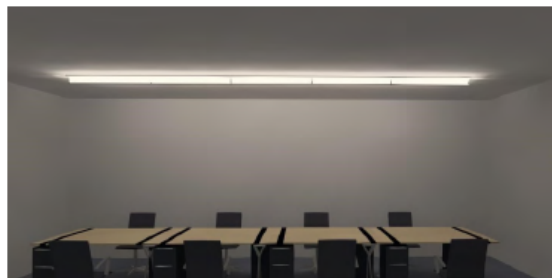

Installation: Suspended

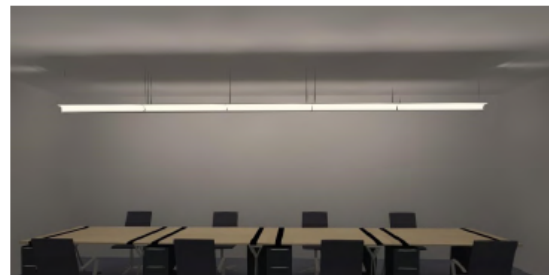

Size
(L*W*H)
1140*220*93