

## LONON(Steel Panel)

Steel and AL Reflector Panel for LED T8 &LED T5



T5 V-Shape Reflector 95% Reflectivity



T8 I-Shape Reflector 85% Reflectivity



Air Slot Type (V or I Shape)



T8 V-Shape Reflector 95% Reflectivity











- V Shape type Material : 0.6mm steel housing with double parabolic imported Mirror-Silver aluminium reflector up to 95%reflectivity b
- I Shape type Material : 0.6mm steel housing with Single parabolic imported Matte-Silver aluminium reflector up to 85%reflectivity b
- Anti rust treated white-painted RAL 9016 sheet steel housing
- Integrated LED Control Gear 1-10V and DALI, and Zigbee wireless and Emergency Kit
- Optional Refelctor : V Shape or I Shape
- Optional Air Slot Type

# LONON(Steel Panel)

Steel and AL Reflector Panel for LED T8 &LED T5

**DIMON**  
TECHNOLOGY

## Technical Data

Luminaire Type- 安裝方式 Tipo de luminaria	Recessed Mount 暗裝式燈具 Montaje empotrado
Dimension-尺寸-Dimensión	W:598x L:598xH:85 mm W:298x L:1198xH:85 mm W:598x L:1198xH:85 mm
Cut-off Dimension -開孔尺寸 Dimensión de corte	W:580x L:580xH:85 mm W:280x L:1180xH:85 mm W:580x L:1180xH:85 mm
Input Voltage-輸入電壓-Voltaje de entrada	AC 220 -240V 50/60HZ
Power Consumption Max 燈具功率 Consumo de energía Max	80W Max Refer to Specification Code and LED Tube Power 80W Max 參考規格代碼和 LED 燈管功率 80 W máx. Consulte el código de especificación y la potencia del tubo LED
LED Driver Type LED驅動款式 Tipo de controlador LED	Integrated-type LED Driver for DC LED T5 / T8 Application--Refer to LED driver specification 請參閱LED驅動器規格Consulte la especificación de controlador de LED 1. ON/OFF Switch AC220-240V 50/60HZ for AC LED T5 / LED T8 2.1-10V Dimming Driver AC220-240V 50/60HZ for DC LED Tube 3. Dali 1-100% Dimming Driver AC220-240V 50/60HZ for DC LED Tube 4. DMX 1-100% Driver AC220-240V 50/60HZ for DC LED Tube 5. ZIGBEE Wireless Control (Remoted Driver ) AC220-240V 50/60HZ for DC LED Tube 6. Emergency Backup >2 hours or >3 hours @ < 12 charger hours 應急電池/Copia de seguridad de emergencia 7. Microwave Sensor : 0-10V control / DALI / ZIGBEE 8. Daylight Sensor : 0-10V control / DALI / ZIGBEE
LED Driver Features Constant Current LED Driver: 驅動特性-恆流LED驅動器 Funciones del controlador de LED	POWER FACTOR : PF>0.90 or PF >0.95 TOTAL HARMONIC DISTORTION: THD< 20% Refer to LED Driver data sheet or LED Tube data sheet
Control Protocol-控制協議 Protocolo de Control	1-10V / Dali / DMX 512 / RDM / ZIGBEE Wireless Control
Beam Angle 光束角 ángulo de haz	Refer to LED T5 / T8 tube data sheet
Photobiological safety-IEC 62471 / of Luminaire 光生物安全檢驗(IEC/EN 62471) 結果: Seguridad fotobiológica-IEC 62471	• Low Risk Group 1 (RG1) Refer to LED T5 / T8 Specification • 低風險組1 (RG1) 參閱LED T5 / T8規格 • Grupo de bajo riesgo 1 (RG1) Consulte la especificación LED T5 / T8
Housing materials-外殼材料 Materiales de la carcasa	Steel sheet with Aluminium reflector鋼板和 鋁反射器 Chapa de acero con reflector de aluminio
Trim Housing Color 框外殼顏色 color de la carcasa	White coating RAL 9016 白色塗層RAL 9016 Recubrimiento blancoRAL 9016
Accessories 配件 Accesorios	Air Slot for cooling, heating and fresh air outlets 空氣槽(冷暖氣和鮮風出口) Conductos de aire (refrigeración, calefacción y salidas de aire fresco)
Reflectivity of Reflector 反射器的反射率 Reflectividad del reflector	• V Shape type :95% reflectivity V 型: 95% 反射率 Tipo V Sharp: 95% de reflectividad • I Shape type : 85% reflectivity I 型: 85% 反射率 Tipo agudo: 85 % de reflectividad
Operating Temperature Range / 工作溫度範圍 Rango de temperatura de funcionamiento	-30 °C / +50 °C
Operating Humidity -工作濕度 Humedad de funcionamiento	0~90%, non-condensing-不結霜 sin condensación
Ingress Protection-防護等級 Protección de ingreso	IP20
Comply Testing Standard 符合測試標準 Cumplir el estándar de prueba	Luminaires: IEC/ EN 60598-1 / EN 60598-2-1 / EN 62031 / EN 62493 LED Driver :IEC/EN 62471 / IEC 60598-2-22 / IEC 62031 /EN 55015 / EN 61000-3-2 / EN 61000-3-3 / EN 61547 LED T5 /T8 :IEC/EN 62471 / IEC 60598-2-22 / IEC 62031 /EN 55015 / EN 61000-3-2 / EN 61000-3-3 / EN 61547 / IEC 62262 / IEC 60529 / IEC TR62778 Luminaries Performance : IEC 62722-1 / IEC 62722-2-1 FSD regulation PPA 105A (4th Rev). RoHS
Certification-認證-Certificación	        

Project	Fixture#	Date
		Firm

## Ordering Information

Choose the option that suits your need and write its corresponding code on the appropriate line to form the product code.

Example product code: [LONON-36W](#)

LONON - \_\_\_\_\_  
POWER

POWER	
Code	Description
<a href="#">12W</a>	2pcs x 2feet 6W LED T5 @ LED T8 598x598mm
<a href="#">16W</a>	2pcs x 2feet 8W LED T5 @ LED T8 598x598mm
<a href="#">20W</a>	2pcs x 2feet 10W LED T5 @ LED T8 598x598mm
<a href="#">24W</a>	3pcs x 2feet 8W LED T5 @ LED T8 598x598mm
<a href="#">36W</a>	3pcs x 2feet 8-12W LED T5 @ LED T8 598x598mm
<a href="#">16W</a>	1pcs x 4feet (16W) LED T5 @ LED T8 LED T5 @ LED T8 298x1198mm
<a href="#">18W</a>	1pcs x 4feet (16W) LED T5 @ LED T8 LED T5 @ LED T8 298x1198mm
<a href="#">32W</a>	2pcs x 4feet (16W) LED T5 @ LED T8 LED T5 @ LED T8 298x1198mm
<a href="#">36W</a>	2pcs x 4feet (18W) LED T5 @ LED T8 LED T5 @ LED T8 298x1198mm
<a href="#">32W</a>	2pcs x 4feet (16W) LED T5 @ LED T8 LED T5 @ LED T8 598x1198mm
<a href="#">36W</a>	2pcs x 4feet (18W) LED T5 @ LED T8 LED T5 @ LED T8 598x1198mm
<a href="#">48W</a>	3pcs x 4feet (16W) LED T5 @ LED T8 LED T5 @ LED T8 598x1198mm
<a href="#">54W</a>	3pcs x 4feet (18W) LED T5 @ LED T8 LED T5 @ LED T8 598x1198mm
<a href="#">60W</a>	3pcs x 4feet (20W) LED T5 @ LED T8 LED T5 @ LED T8 598x1198mm
<a href="#">72W</a>	3pcs x 4feet (24W) LED T5 @ LED T8 LED T5 @ LED T8 598x1198mm
<a href="#">78W</a>	3pcs x 4feet (26W) LED T5 @ LED T8 LED T5 @ LED T8 598x1198mm

# Beam Angle

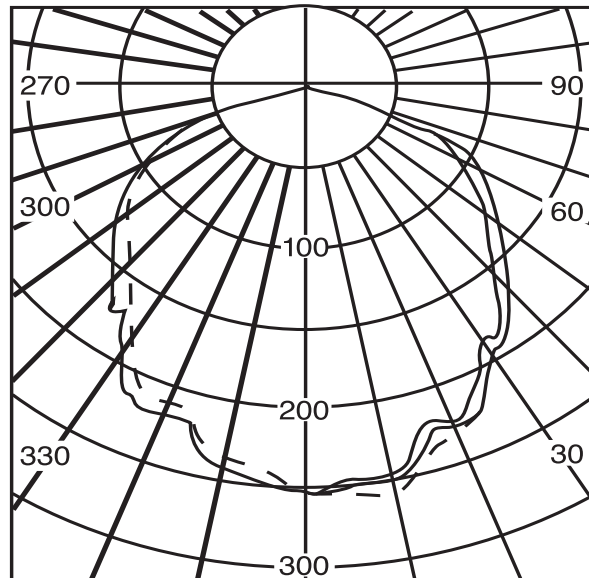

1-10v / Dali / Zibee dimming wiring diagram

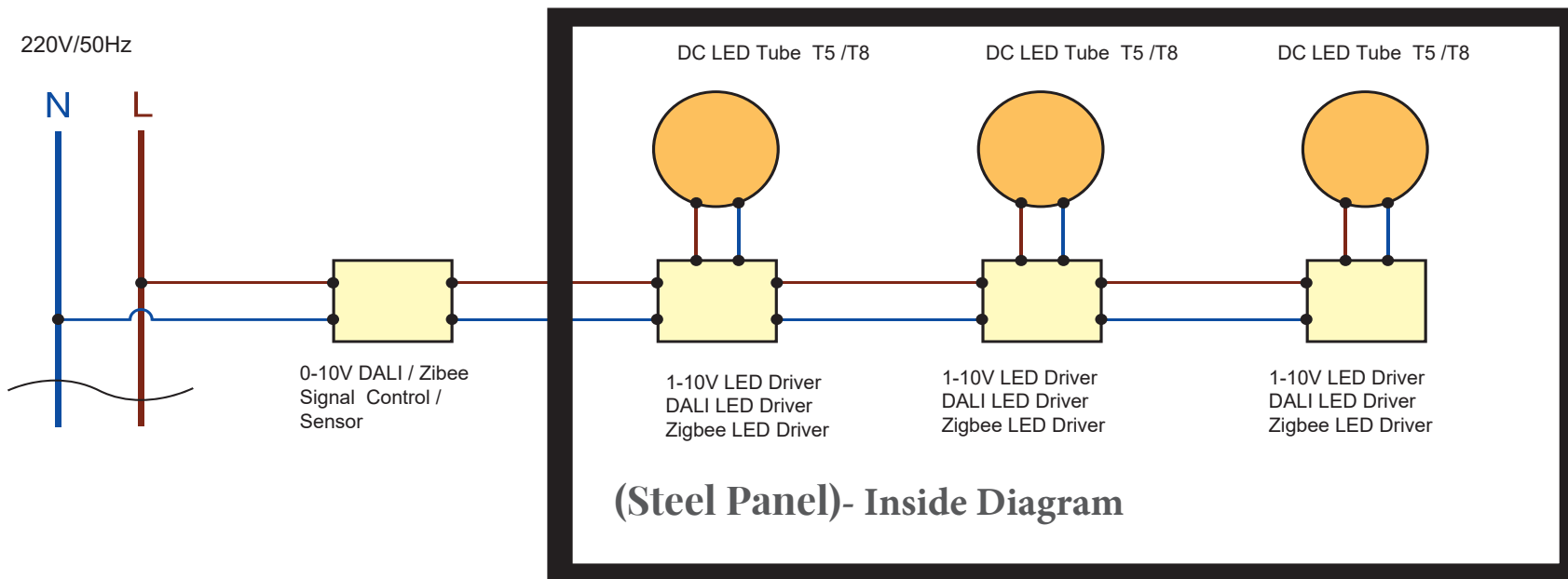

# Technical Drawing for LED T5

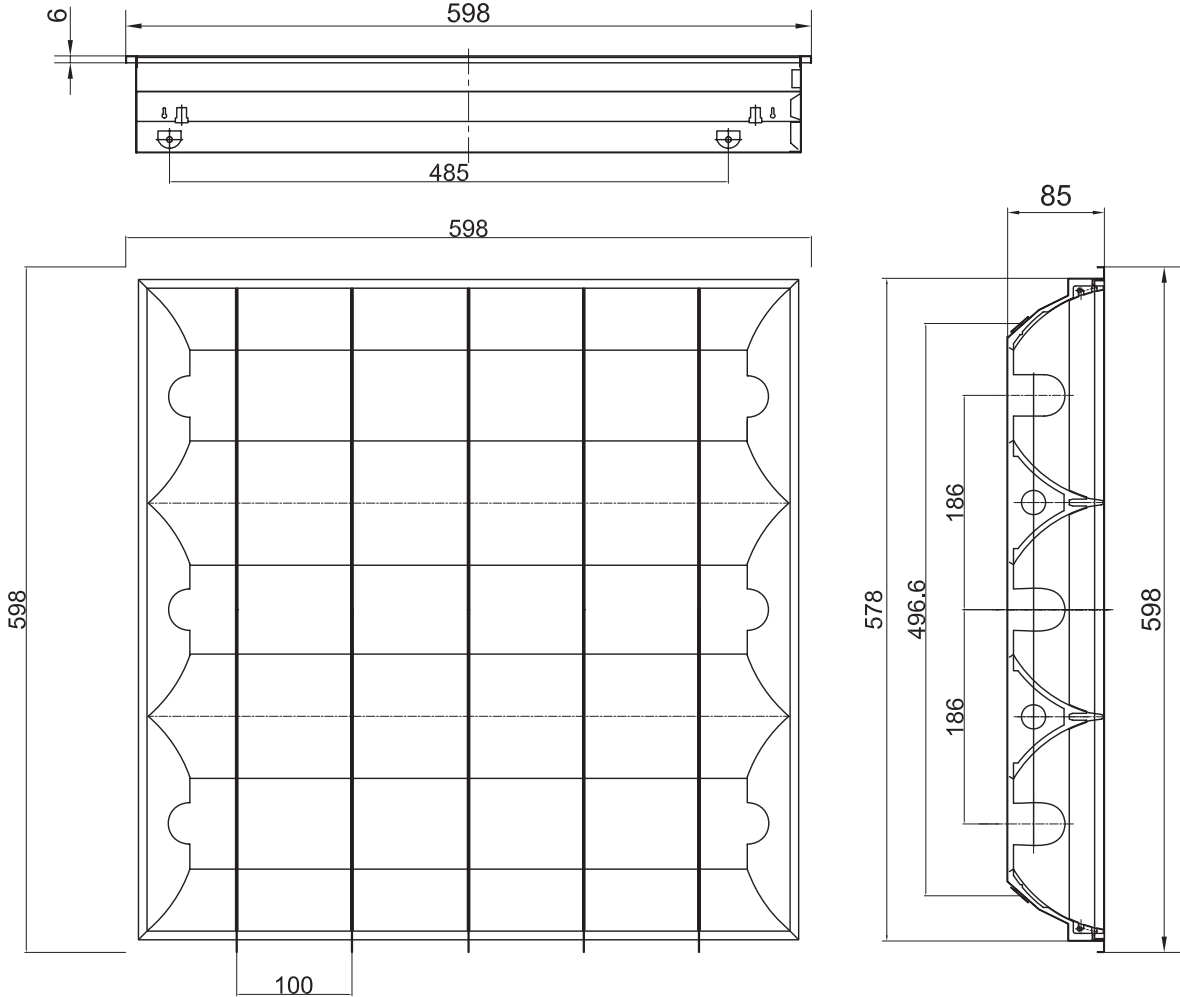

Cut-off: 580x580mm

Unit : mm

# Technical Drawing for LED T5

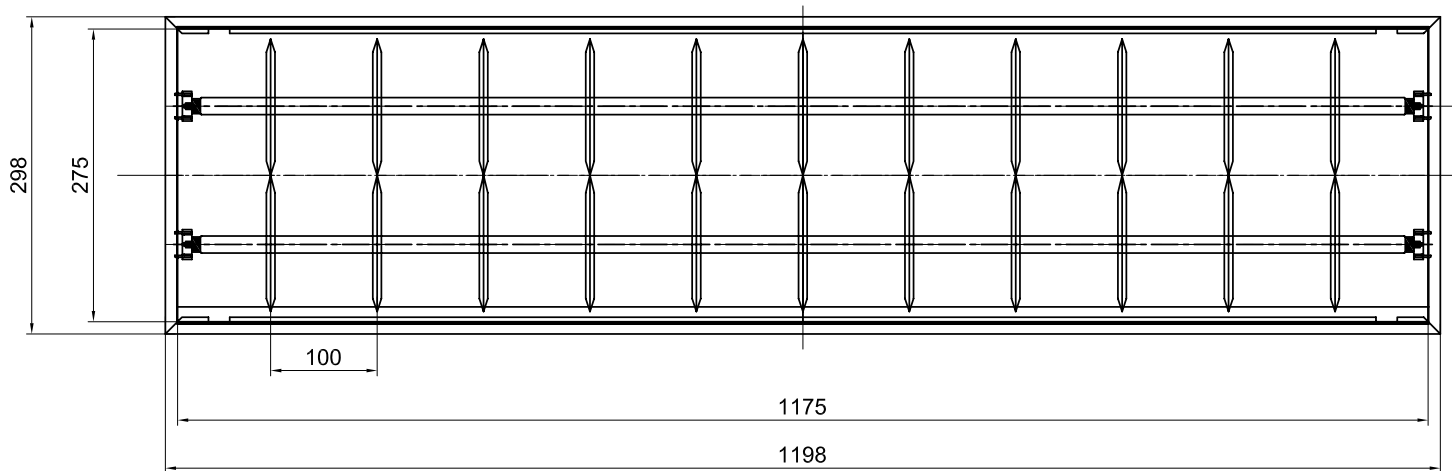
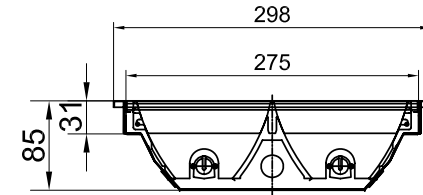
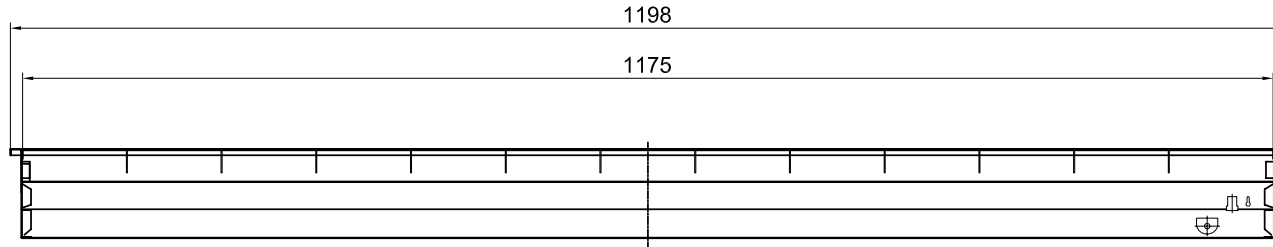

Cut-off: 1180x280mm

Unit : mm

# Technical Drawing for LED T5

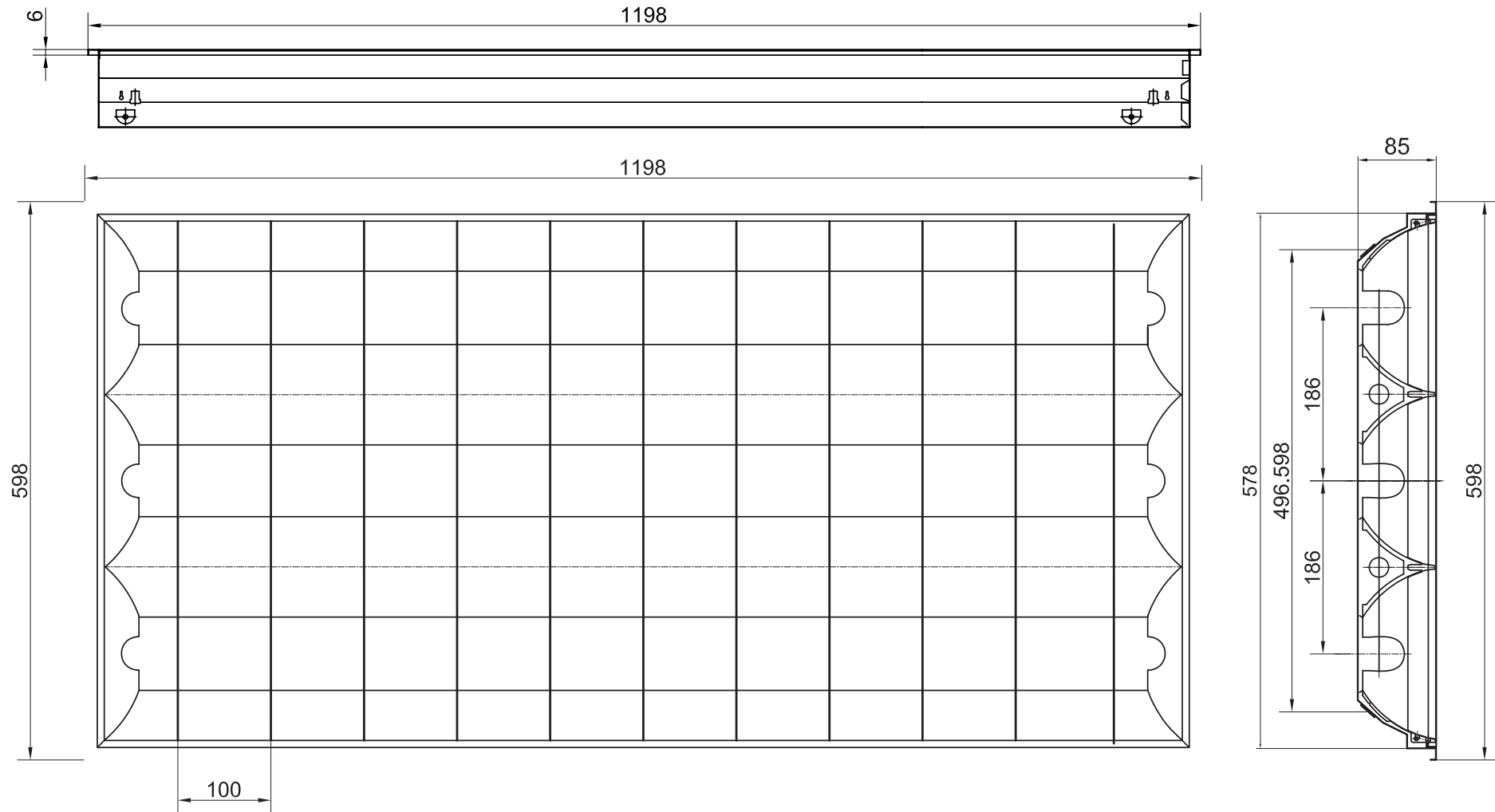

Cut-off: 1180x580mm

Unit : mm



# Technical Drawing for Air-slot

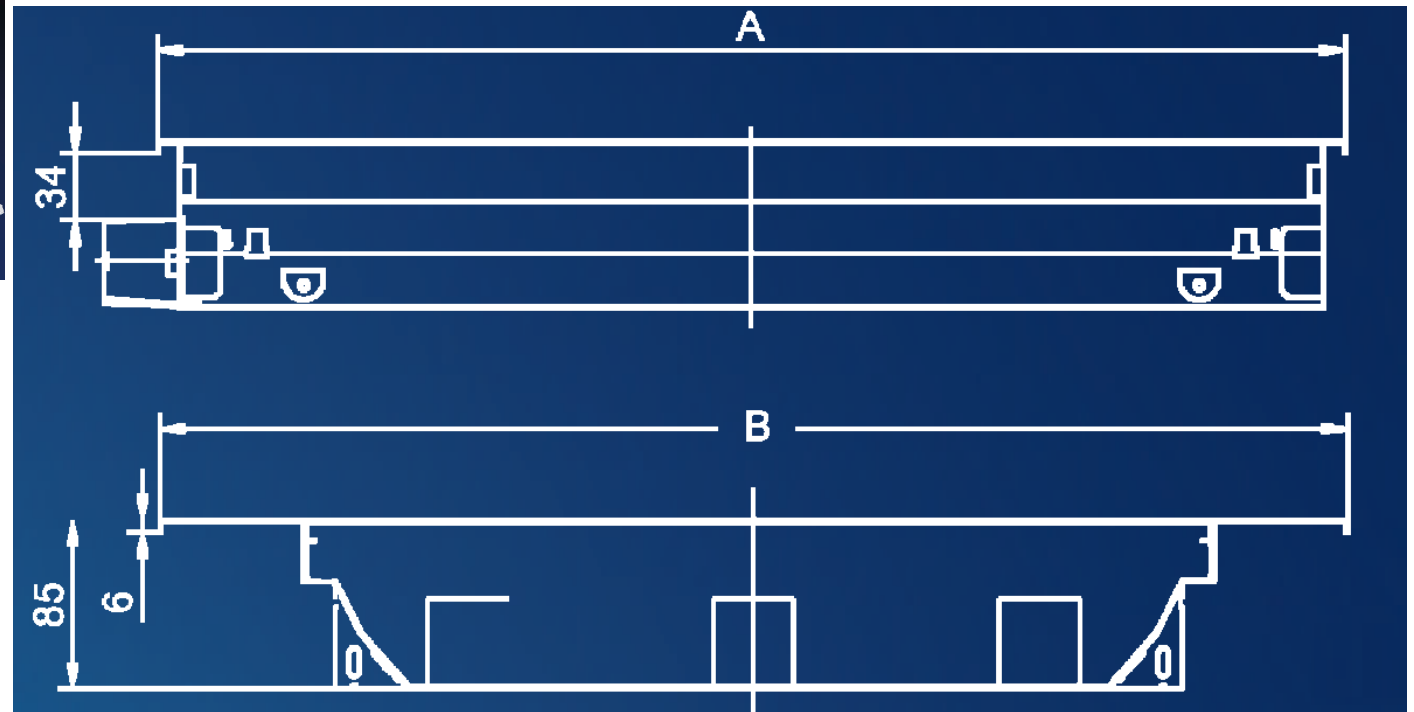

A (mm)	B (mm)	C (mm)
1195	595	85
1195	295	85
595	595	85

# Technical Drawing for LED T8

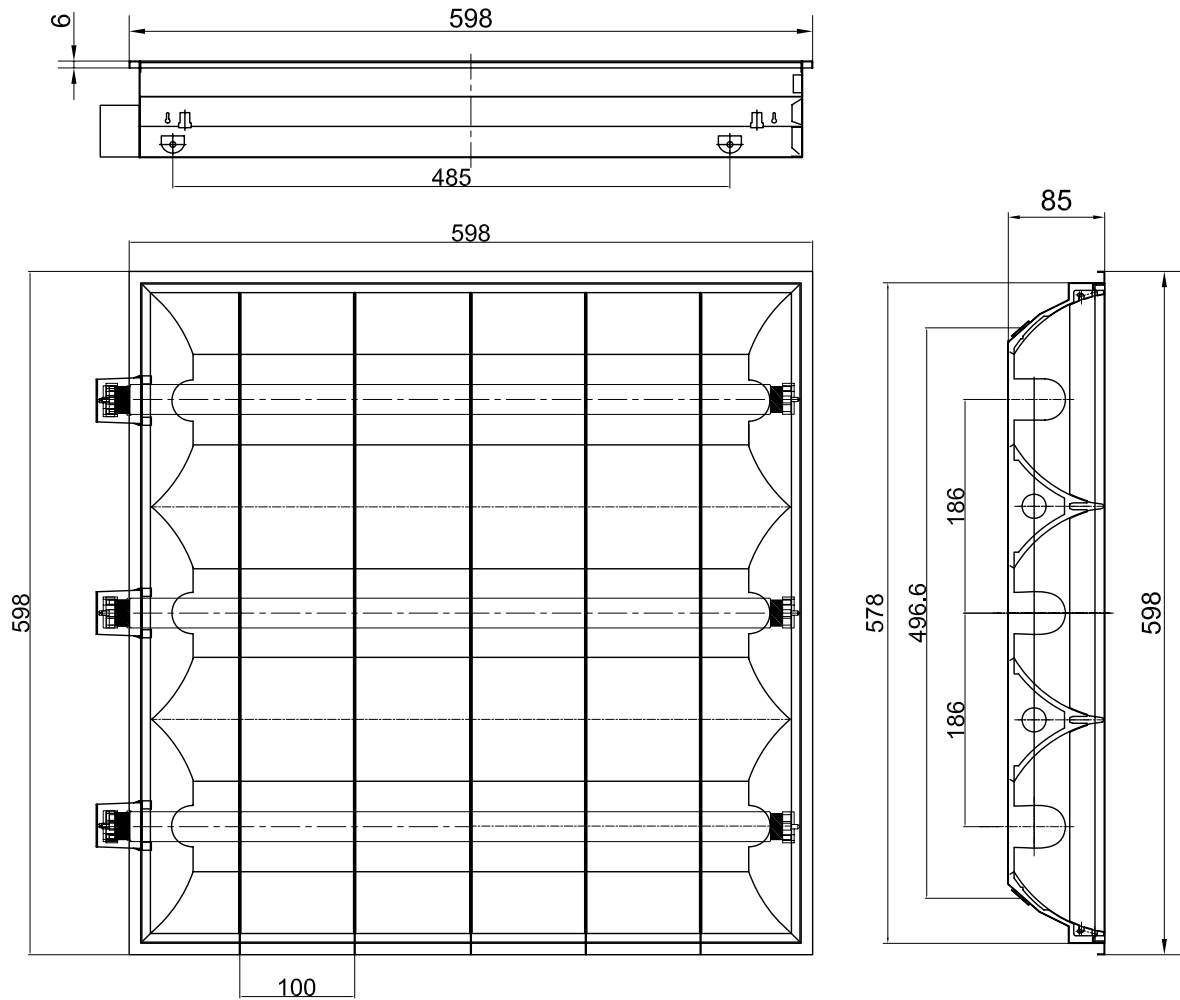

Cut-off: 580x580mm

Unit : mm

# Technical Drawing for LED T8

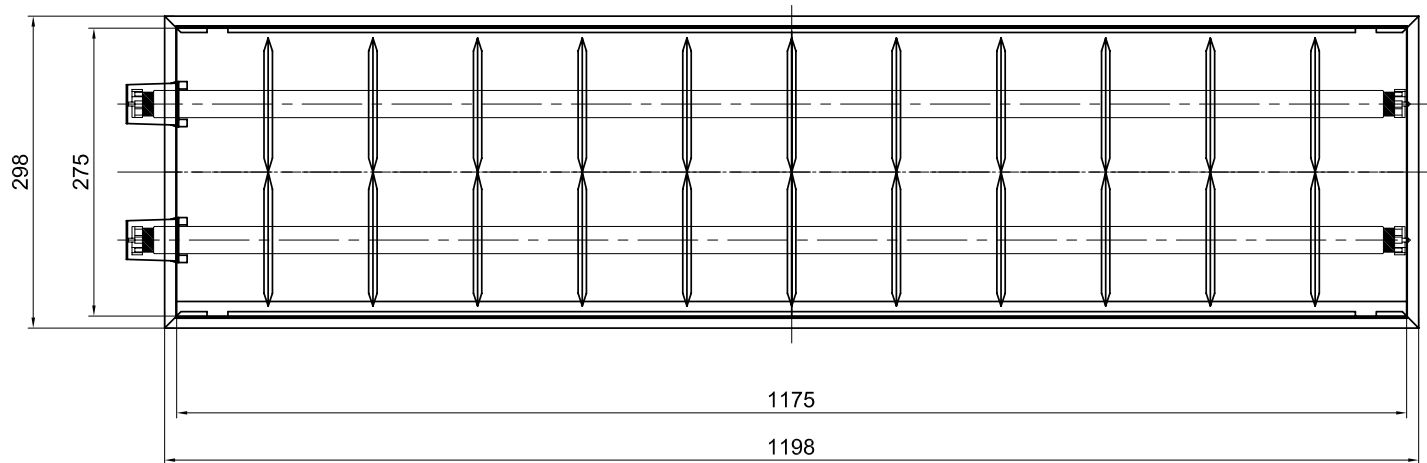
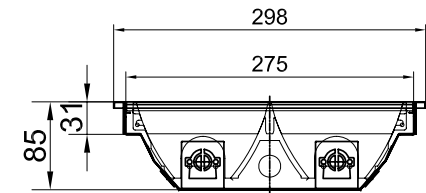
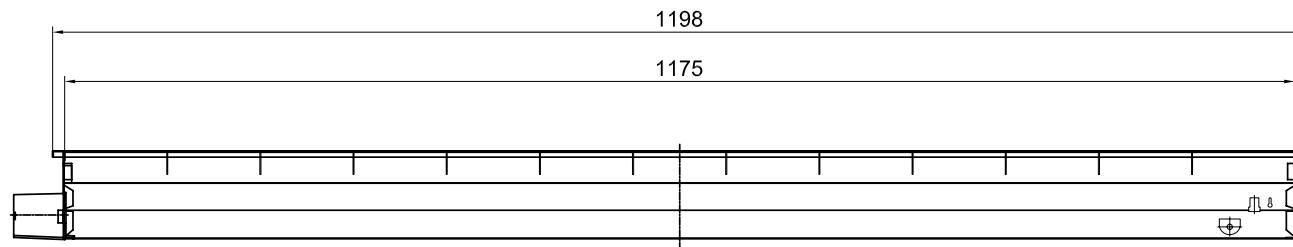

Cut-off: 1180x280mm

Unit : mm

# Technical Drawing for LED T8

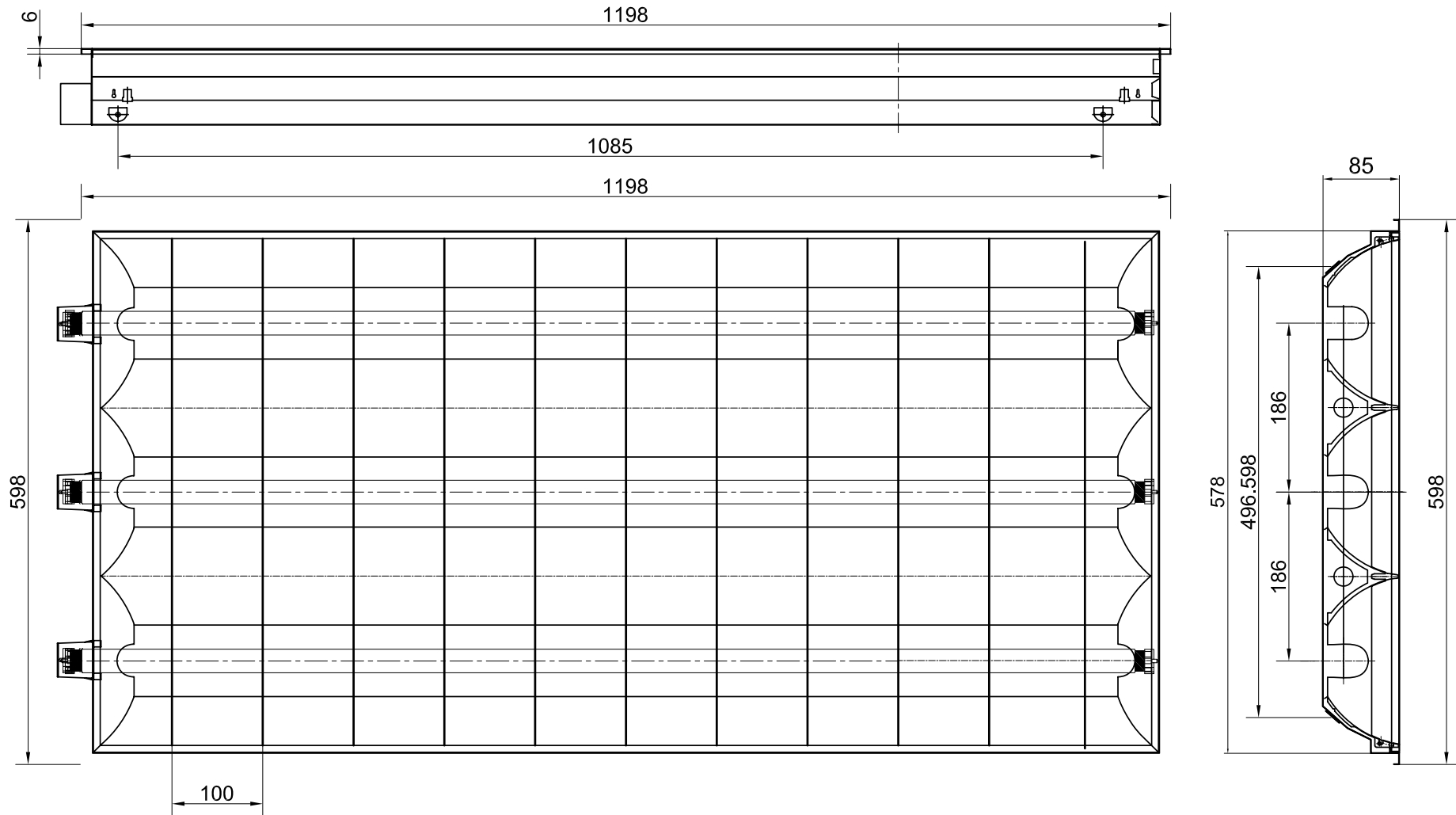

Cut-off: 1180x580mm

Unit : mm