

# PONEE

18W-72W H:9.7mm EU UGR<19 IP40



Opal Plate diffuser





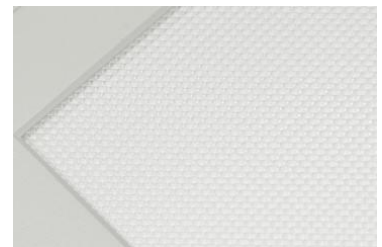







Suspended Mounted



Prismatic Plate diffuser

Recessed or surface mounted Diffused LED Luminaire with High Uniformity Microprismatic system to Low glare (UGR<19). White Painted Aluminium frame with reflective sheet (PET) and Opal or Prismatic Plate diffuser. Fixed Ouptut LED Driver .CCT Adjustable (2700K-6500K) can be option.

## Technical Data

Luminaire Type- 安裝方式 Tipo de luminaria	Recessed & Surface & Suspended Mounted 嵌入式, 明裝或吊裝 Empotrado y superficie y suspendido montado
Power Consumption with LED Driver LED燈具包括LED驅動電源功率 Consumo de energía con controlador de LED	<ul style="list-style-type: none"> <li>• 18W@ L: 295mm x W: 295mm or L: 595mm x W: 295mm or L: 595mm x W: 595mm or L: 295mm x W: 1195mm</li> <li>• 26W@ L: 595mm x W: 295mm or L: 595mm x W: 595mm or L: 295mm x W: 1195mm</li> <li>• 28W@ L: 595mm x W: 595mm or L: 295mm x W: 1195mm or L: 595mm x W: 1195mm</li> <li>• 31W@ L: 595mm x W: 595mm or L: 295mm x W: 1195mm or L: 595mm x W: 1195mm</li> <li>• 34W@ L: 595mm x W: 595mm or L: 295mm x W: 1195mm or L: 595mm x W: 1195mm</li> <li>• 36W@ L: 595mm x W: 595mm or L: 295mm x W: 1195mm or L: 595mm x W: 1195mm</li> <li>• 40W@ L: 595mm x W: 595mm or L: 295mm x W: 1195mm or L: 595mm x W: 1195mm</li> <li>• 48W@ L: 595mm x W: 595mm or L: 295mm x W: 1195mm or L: 595mm x W: 1195mm</li> <li>• 54W@ L: 595mm x W: 1195mm</li> <li>• 60W@ L: 595mm x W: 1195mm</li> <li>• 64W@ L: 595mm x W: 1195mm</li> <li>• 72W@ L: 595mm x W: 1195mm</li> </ul>
Input Voltage / 輸入電壓 Voltaje de entrada	220-240V/AC 50/60Hz (with remote driver)
LED Driver Type LED驅動款式 Tipo de controlador LED	Remote-type LED Driver--Constant Current LED Driver Refer to LED driver specification 請參閱LED驅動器規格 Consulte la especificación de controlador de LED 1. ON/OFF Switch AC220-240V 50/60HZ 3. 1-10V Dimming Driver AC220-240V 50/60HZ 4. Dali Dimming 1-100% Driver AC220-240V 50/60HZ 5. DMX Driver 1-100%AC220-240V 50/60HZ 6. RDM Driver 1-100% AC220-240V 50/60HZ 7. ZIGBEE Wireless Control (Remoted Driver ) AC220-240V 50/60HZ 8. Emergency Backup >2 hours or >3 hours @ < 24 charger hours應急電池/Copia de seguridad de emergencia
LED Driver Features Constant Current LED Driver: 驅動特性-恆流LED驅動器 Funciones del controlador de LED	<ul style="list-style-type: none"> <li>• POWER FACTOR : PF&gt;0.90 @ Full Load</li> <li>• TOTAL HARMONIC DISTORTION: THD&lt; 20%</li> <li>• Refer to LED Driver data sheet</li> </ul>
Control Protocol/控制協議/Protocolo de Control	1-10V / Dali / DMX 512 / RDM / ZIGBEE Wireless Control
Light Source Brand-光源品牌-Fuente de luz de marca	OSRAM - ( Photobiological safety-IEC 62471 'Risk Group 1' (low risk) )
"Lumen Maintenance LM-80 Reported by TM-21"@ 25°C	L80(10k) > 63,500 hrs L70(10k) > 65,000 hrs
LED Life-LED壽命-La vida del LED	>60,000 hours
Color Temperature -色溫 Temperatura del color	2700K / 3000K / 4000K / 5000K /6000K / 6500K / Tunable White (2700K-6500K)
Color Rendering Index-顯色指數 Índice de reproducción cromática	>80 >90
MacAdam Ellipses Binning 麥克亞當橢圓分級 Mac Adam binning elipse	Standard Deviation Colour Matching < 3 SDCM 標準偏差配色< 3 SDCM Coincidencia de color estándar Desviación < 3 SDCM
Beam Angle光東角ángulo de haz	110 °
Luminaire Efficacy 燈具效率 La eficacia de la luminaria	<ul style="list-style-type: none"> <li>• 110 Lm/w(2700K) 110 Lm/w(3000K) 120 Lm/w(4000K)</li> <li>• 120 Lm/w(5000K) 120 Lm/w(6000K) 120 Lm/w(6500K)</li> </ul>
LED Source Luminous EfficacyLED光源光效 Fuente luminosa LED Eficacia	<ul style="list-style-type: none"> <li>• 130 Lm/w(2700K) 130 Lm/w(3000K) 140 Lm/w(4000K)</li> <li>• 140 Lm/w(5000K) 140 Lm/w(6000K) 140 Lm/w(6500K)</li> </ul>
Housing materials 外殼材料 Materiales de la carcasa	Aluminum and Polystyrene with prism diffuser and PMMA (Light Guid Plate) 鋁和聚苯乙烯 (菱晶擴散板)和亞克力導光板 Difusor de aluminio y poliestireno con Prism y PMMA (luz guid Plate)
Housing Color 外殼顏色 color de la carcasa	White Painted Aluminium frame and Opal or Prismatic Plate diffuser 白色鋁框和乳白或水晶紋面 Cuadro de aluminio pintado blanco y difusor de placa opal o prismático.
Ingress Protection-防護等級 Protección de ingreso	IP40
Operating Temperature Range / 工作溫度範圍 Rango de temperatura de funcionamiento	-20 °C / +50 °C
Operating Humidity /工作濕度/Humedad de funcionamiento	0~90%, non-condensing-不結霜sin condensación
Dimension / Weight 尺寸/重量 Dimensión / Peso	<ul style="list-style-type: none"> <li>• L: 295mm x W: 295mm x H: 9.7 mm ( H: 39mm with Remoted LED Driver ) / 1.0kg</li> <li>• L: 595mm x W: 295mm x H: 9.7 mm ( H: 39mm with Remoted LED Driver ) / 1.6kg</li> <li>• L: 595mm x W: 595mm x H: 9.7 mm( H: 39mm with Remoted LED Driver ) / 2.9kg</li> <li>• L: 1195mm x W: 295mm x H: 9.7 mm( H: 39mm with Remoted LED Driver ) / 2.9kg</li> <li>• L: 1195mm x W: 595mm x H: 9.7 mm ( H: 39mm with Remoted LED Driver ) / 5.6 kg</li> </ul>
Comply Testing Standard 符合測試標準 Cumplir el estándar de prueba	LED Luminaries: LVD: IEC/EN 60598-1;EN / IEC/EN 60598-2-1;IEC62471;IEC/EN 62031; IEC/EN 62493 ; IEC/EN 62471 (Risk Group 1) LED Driver: IEC/EN 61347-1; IEC/EN 61347-2-13; IEC/EN 62384; IEC/EN 61000-3-2; IEC/EN 61000-3-3;IEC/EN61574;EN 55015 ; IEC /EN 62384
Certification-認證-Certificación	         

Project	Fixture#	Date
		Firm



## Ordering Information

Choose the option that suits your need and write its corresponding code on the appropriate line to form the product code.

Example product code: [PONEE-36W](#)

PONEE - -

POWER  
CONSUMPTION

POWER CONSUMPTION	
Code	Description
<a href="#">18W</a>	18W@L:295mm x W:295mm or L:595mm x W:295mm or L: 595mm x W: 595mm or L: 295mm x W: 1195mm
<a href="#">26W</a>	26W@L: 595mm x W:295mm or L:595mm x W:595mm or L:295mm x W:1195mm
<a href="#">28W</a>	28W@L:595mm x W:595mm or L:295mm x W:1195mm or L:595mm x W:1195mm
<a href="#">31W</a>	31W@L:595mm x W:595mm or L:295mm x W:1195mm or L:595mm x W:1195mm
<a href="#">34W</a>	34W@ L:595mm x W:595mm or L:295mm x W:1195mm or L:595mm x W:1195mm
<a href="#">36W</a>	36W@L: 595mm x W:595mm or L:295mm x W:1195mm or L:595mm x W:1195mm
<a href="#">40W</a>	40W@L: 595mm x W:595mm or L:295mm x W:1195mm or L:595mm x W:1195mm
<a href="#">48W</a>	48W@L: 595mm x W:595mm or L:295mm x W:1195mm or L:595mm x W:1195mm
<a href="#">54W</a>	54W@ L:595mm x W:1195mm
<a href="#">60W</a>	60W@ L:595mm x W:1195mm
<a href="#">64W</a>	64W@ L:595mm x W:1195mm
<a href="#">72W</a>	72W@ L:595mm x W:1195mm

BEAM ANGLE

110°

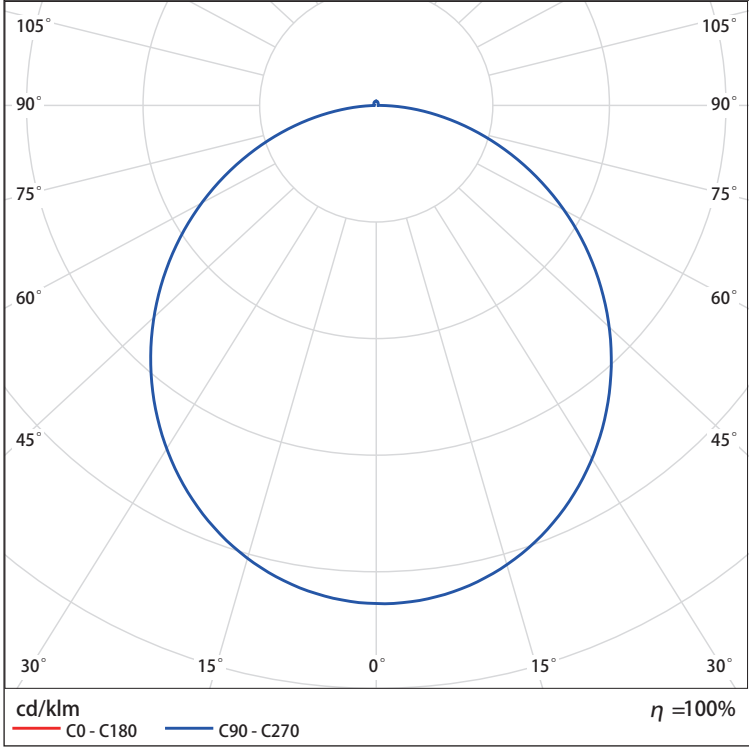

# Technical Drawing

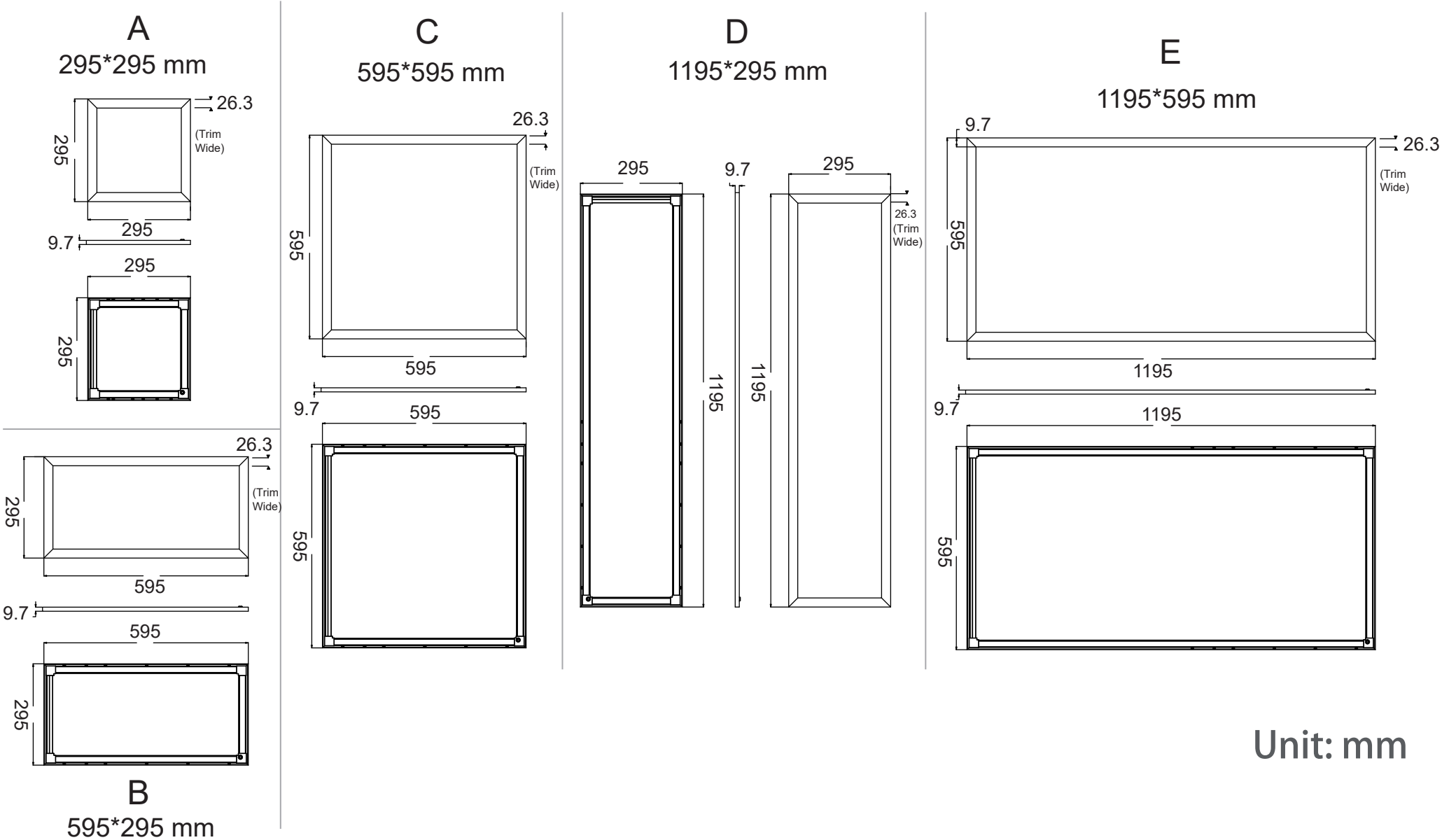

Unit: mm