

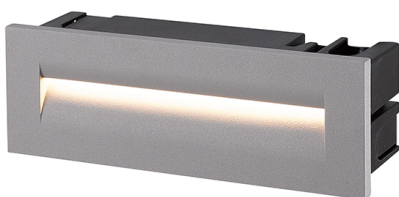

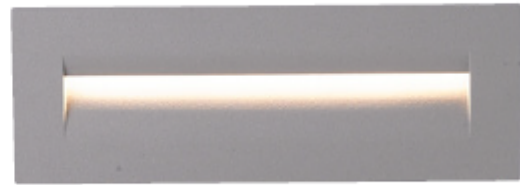



## WOYE-L

6W-10W IP66

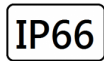

- Body and bracket in die-cast aluminium with Anti UV Clear PC Lens
- Corrosion -resistance Powder coated
- Ingress Protection: IP66 and IK10 Mech impact protection
- ABS plastic recessed housing.
- Integrated-Type 1-10V, DALI Dimming control gear

## Technical Data

Luminaire Type-安裝方式 Tipo de luminaria	Recessed Wall Light Type嵌入式燈具 Tipo de Recessed
Dimension-尺寸-Dimensión	W: 250 x H: 87 x D: 73 mm
Input Voltage-輸入電壓-Voltaje de entrada	AC220-240V 50/60HZ
Power Consumption Max-燈具功率 Consumo de energía Max	6W    8W    10W
LED Driver Type LED驅動款式 Tipo de controlador LED	Integrated-type LED Driver--Refer to LED driver specification 請參閱LED驅動器規格 Consulte la especificación de controlador de LED 1. ON/OFF Switch AC100-240V 50/60HZ 2. 1-10V Dimming Driver AC100-240V 50/60HZ 3. Dali Dimming Driver AC100-240V 50/60HZ
Control Protocol-控制協議 Protocolo de Control	1-10V / Dali
Total Harmonic Distortion/總諧波失/Distorsión armónica total	THD<20%
Power Factor / 功率因數/Factor de potencia	PF>0.9
Beam Angle光束角ángulo de haz	Asymmetric
Light Source Brand-光源品牌-Fuente de luz de marca	LUMILEDS
"Lumen Maintenance LM-80 Reported by TM-21"	L70> 54,000 hrs
LED Life-LED壽命-La vida del LED	>60,000 hours
Color Temperature -色溫 Temperatura del color	3000K / 4000K / 5000K
Color Rendering Index-顯色指數 Índice de reproducción cromática	> 80
MacAdam Ellipses Binning 麥克亞當橢圓分級 Mac Adam binning elipse	Standard Deviation Colour Matching < 3 SDCM標準偏差配色< 3 SDCM Coincidencia de color estándar Desviación < 3 SDCM
Luminaire Efficacy燈具效率 La eficacia de la luminaria	40 Lm/w(3000K),    50 Lm/w(4000K),    50 Lm/w(5000K),
LED Source Luminous EfficacyLED光源光效 Fuente luminosa LED Eficacia	120 Lm/w(3000K),    130 Lm/w(4000K),    130 Lm/w(5000K),
Housing materials-外殼材料 Materiales de la carcasa	Die-cast aluminium with Anti UV asymmetric optically Clear PC Lens抗紫外線不對稱光學透明 PC 透鏡 Aluminio fundido a presión con lentes de PC transparentes ópticamente asimétricas anti U
Housing Color外殼顏色color de la carcasa	Sand White RAL 9003 / Sand Black RAL 9005 / Dark Gray RAL7043 砂白RAL 9003 / 砂黑 RAL 9005 / 深灰色 RAL7043 Blanco arena RAL 9003 / Negro arena RAL 9005 / Gris arena RAL9006
Ingress Protection-防護等級 Protección de ingreso	IP66
Mech impact protection 機械衝擊保護 Protección contra impactos mecánicos	IK10
Operating Humidity -工作濕度 Humedad de funcionamiento	0~100%, non-condensing-不結霜 sin condensación
Operating Temperature Range / 工作溫度範圍 Rango de temperatura de funcion amiento	-30 °C / +50 °C
Comply Testing Standard 符合測試標準 Cumplir el estándar de prueba	LED Luminaries: LVD: IEC/EN 60598-1;EN / IEC/EN 60598-2-2;IEC62471;IEC/EN 62031; IEC/EN 62493 ; IEC/EN 62471 (Risk Group 1) • LED Driver: IEC/EN 61347-1; IEC/EN 61347-2-13; IEC/EN 62384; IEC/EN 61000-3-2; • IEC/EN 61000-3-3;IEC/EN61574;EN 55015 ; IEC /EN 62384
Certification-認證-Certificación	      



# Beam Angle

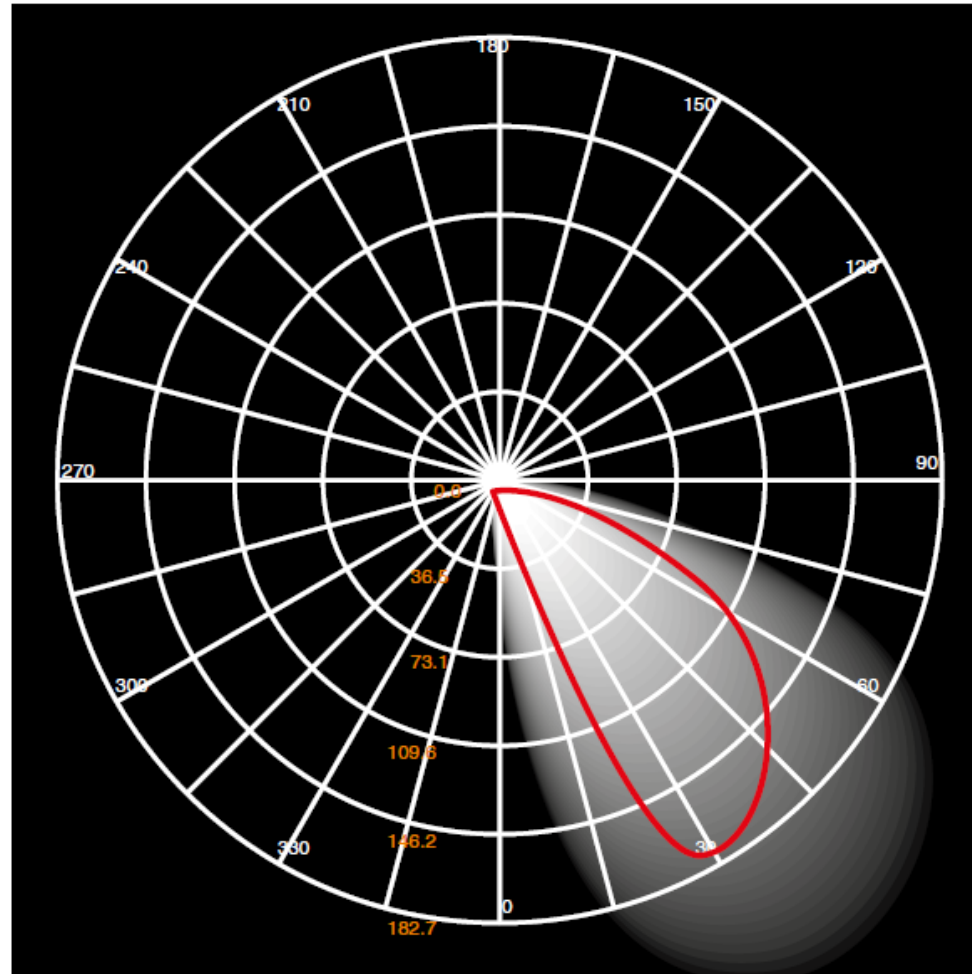

# Technical Drawing

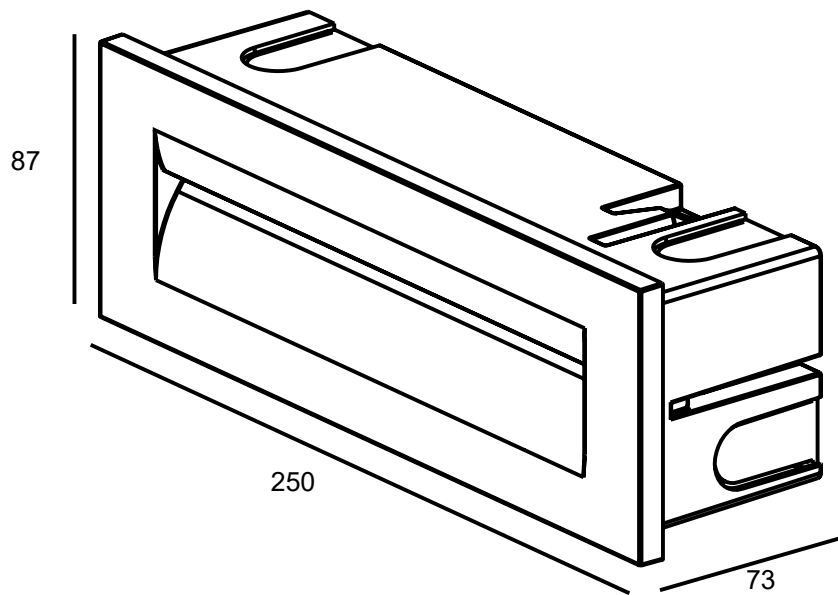

# Installation Menu

